



N presenting our 1896 Catalogue to our patrons and the trade in general, we desire to especially call attention to the combined form in which we now represent, under one cover, both our POP SAFETY VALVES and GAGES, these lines of meritorious specialties, being shown in the most complete form and fully illustrated with cuts, and accompanied with detailed information.

THE ASHTON POP SAFETY VALVES have been on the market for more than twenty years, during which time they have held an unequalled reputation. Valuable patented improvements on them have been made from time to time, and the highest quality of material and workmanship has always been put into their construction, while many competitors have sacrificed the quality of their goods in order to reach low prices. ASHTON VALVES are considered the standard by the majority of the first-class steam-users, and can always be depended upon as the most reliable, durable, and efficient.

Although it is but three years and a half since the Gage Department was added to our business, we have in this time, notwithstanding the general depression, built up an excellent trade in this line, for which we have good reason to be proud. Several of the largest railroads have adopted our gages as their standard, besides which we have a valuable list of customers among the largest mills and electric power plants. ASHTON GAGES are constructed the same in quality as are the Ashton Pop Safety Valves. They are the best,—challenging comparison,—and are sold wholly on their merits.

We wish to extend our sincere thanks to the many friends who have so liberally favored us with their patronage in the past, and trust that we shall continue to merit even a larger share in the future.

Faithfully yours,

THE ASHTON VALVE CO.



HENRY G. ASHTON,
Founder of
The Ashton Valve Company.

Ashton Patents in General



OVER broadly the most valuable and desirable improvements in Pop Safety Valves and Gages made in recent years. It has been our aim and study to devise the most practical, efficient, and durable goods possible in the state of the art. By constant and careful attention, we keep ourselves fully informed of all meritorious inventions of others and do not hesitate to strengthen our position by purchasing such as are of value.

From time to time, as is the case with all companies holding valuable patents, law-suits have been brought against us claiming infringement, but in not a single case have the courts decided against the validity of our patents. We guarantee protection to our customers from litigation, and will save them harmless from all loss, cost, damage, and expense arising from the use of our goods.

"ASHTON" POINTERS.

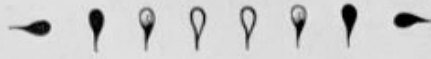

BOILERS CANNOT KEEP THEMSELVES IN GOOD CONDITION.

DON'T NEGLECT THEM.

ALWAYS HAVE YOUR SAFETY VALVE LARGE ENOUGH.

Connect the valve with the Boiler as close and direct as possible; use but little red lead, and carefully remove all dirt, sediment, or scale from joints or pipe, so that valve may close tight without injury to the seat.

USE CARE IN PUTTING VALVES ON.

SET VALVES CAREFULLY.

TRY SAFETY VALVE AT LEAST ONCE A DAY.

RAISE SAFETY VALVE SLOWLY AND CAUTIOUSLY.

SEE THAT SAFETY VALVE AND GAGE AGREE.

BE SURE YOUR VALVE RELIEVES YOUR BOILER.

NEVER USE PIPE TONGS ON SHELLS OF COMPOSITION VALVES.

KEEP YOUR VALVES IN ORDER.

KEEP PIPES AND CONNECTIONS CLEAN.

REPAIR ALL LEAKS AT ONCE.

PREVENT ALL USELESS NOISES.

DON'T HAVE GASKET OVERHANG INLET.

NEVER REDUCE INLETS TO VALVES.

THE BEST IS NONE TOO GOOD.

WE ALWAYS ADVOCATE THE BEST.

THE BEST VALVES ARE THE CHEAPEST.

HELP YOUR ENGINEER BY GOOD STEAM APPLIANCES.

PUT ASHTON VALVES INTO NEW SPECIFICATIONS.

ALWAYS SPECIFY ASHTON GAGES.

INFORMATION GLADLY GIVEN.

SEND FOR CATALOGUE.

READ CAREFULLY PRESERVE FOR VALUABLE REFERENCE.

DISCOUNTS GIVEN ON APPLICATION.

REPAIRS.

Many first-class mills and factories are frequently greatly bothered for want of good facilities in making repairs on their steam and water equipments. Send them to us at once; we will give them immediate attention, and, with our corps of skilled workmen, save you many dollars. New goods can be obtained at either office; all repair jobs should be addressed to the home office.

If you contemplate changes or extensions, send for our Catalogue. Estimates cheerfully furnished.

The Best is always found to be the cheapest in the end.



SEVEN
HIGHEST
AWARDS

BOTH
GOLD
AND
SILVER
MEDALS





MEDAL
AND
HIGHEST
AWARDS

AT
COLUMBIAN
EXPOSITION
CHICAGO
1893



The Ashton Lock-up Pop Safety Valves.

GENERAL DESCRIPTION.

THE mechanical principles upon which our valves are constructed, and the philosophy embodied in their proportions, make them the most perfect and efficient safety valves of which we have any knowledge. When of suitable capacity, these valves give instant and perfect relief to the boiler, and it is impossible to accumulate pressure above the point at which they are set. They are sensitive in action and always reliable. At the given pressure the valve will rise, and cannot be stopped blowing until the relief is given, when the valve will close itself, being perfectly automatic in its working, with nothing to disarrange or get out of order.

The Ashton Pop Safety Valves have now been on the market for more than twenty years, during which time they have met with unusual success and held an unequalled reputation. It has always been the policy of the company to make their product in quality of material and workmanship the best possibly attainable in the state of the art. The result is that Ashton goods are recognized as being the most reliable and durable. Their points of mechanical superiority are explained in detail on the following pages, 9, 10, and 11, and, as will be appreciated by all mechanics, architects, and engineers, embody

The Ashton Lock-up Pop Safety Valve.

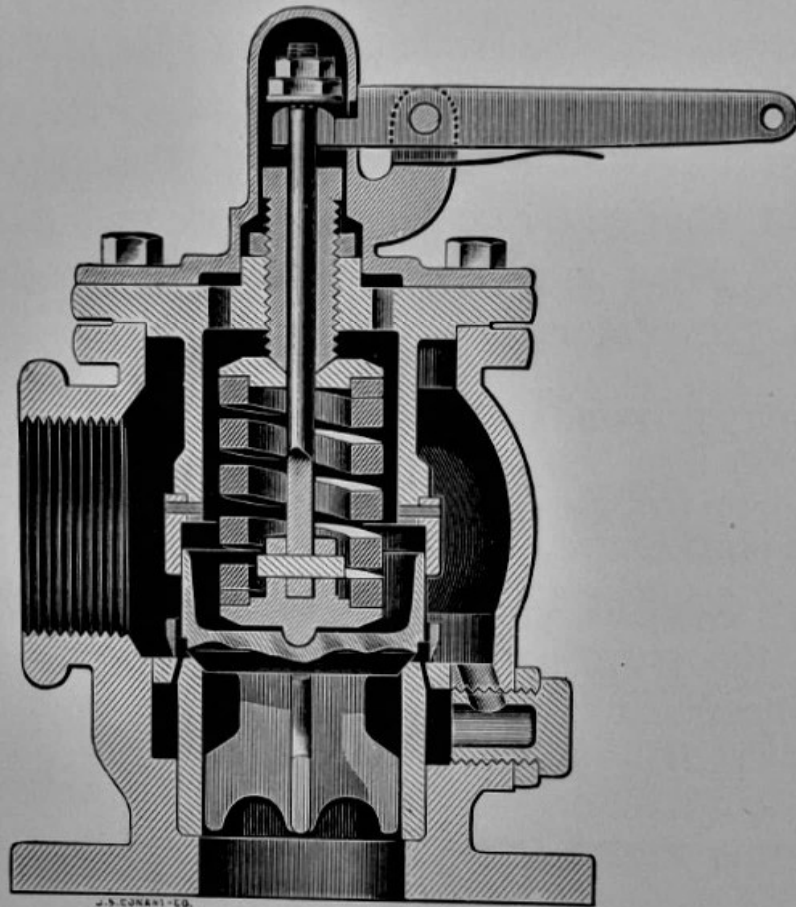

POINTS OF MECHANICAL SUPERIORITY.

BEVEL SEATS.

ALL Ashton Valves are made with bevel seats at an angle of 45 degrees, same as the United States Government standard. Bevel seats always keep tighter than flat seats, and are easier to grind in or face off when repairs are necessary.

COMPOSITION, OR NICKEL SEATS.

Our standard seat is made of extra quality composition metal equal to United States Government standard, with great wearing qualities, and free from corrosion. *Nickel seats* of the highest grade are furnished, if desired, at no extra expense.

POINTS OF MECHANICAL SUPERIORITY. — *Continued.***POP CHAMBER AND KNIFE-EDGE LIP.**

The pop chamber in Ashton Valves is of special design. It is the chamber as surrounded by the patented knife-edge lip and inclosed within the walls of this lip and the top of the bushing and valve seat. The knife-edge lip wears down in proportion to the wear of the seat of the valve, thus keeping the outlet of the pop chamber of the same relative proportion to the inlet, giving an unvarying pop and insuring long service without readjustment or repairs.

SUPPLEMENTAL POP CHAMBER.

In valves above 2 inches in size the supplemental pop chamber is introduced. This chamber is connected with the primary pop chamber by a series of holes through the bushing, and serves the purpose of making a close regulation of the pop by the adjustment of its outlet passage into the discharge chamber, as further explained in the following paragraph.

OUTSIDE POP REGULATOR.

The patent screw plug pop regulator H, on the outside of our valves, free from corrosion or any possible chance of sticking, affords means of regulating the pop of the valve at all times without taking the valve apart, and when steam is on the boiler. By use of this regulator, any desired pop can be obtained down to the finest regulation, thus reducing the waste of steam to a minimum. Full explanation how to regulate given on page 13.

EXTRA QUALITY SPRINGS.

All our pop valve springs are made in our own factory, of Jessop's best steel, and have no superior in the world. They are ground perfectly square on the ends, and before being put into use are subjected to the severest tests that can be given them.

BLOW-BACK HEAD AND ENCASED SPRING.

Valves above 2 inches in size are made with *our patent blow-back head*, forming a chamber inclosing the spring and protecting it from the great volume of steam. It also makes an additional guide for the valve above the seat. This spring chamber is vented at the top, and thereby offers the great advantage of piping the discharge of any number of valves together, or through any length of pipe having innumerable elbows, and yet the valve will not be loaded with back pressure. All other pop valves under such circumstances would have a dangerous back-pressure on the top of the valve. This is impossible with the Ashton patent blow-back head or vented spring chamber.

ADVANTAGEOUS POSITION OF INLET AND OUTLET.

Another feature of great advantage to engineers is, that the inlet and outlet are both on the base casting, whereby the valve can be taken apart and reground, or otherwise repaired, without breaking boiler connection or outlet pipe.

LOCK-UP ATTACHMENT.

Most valves are furnished with lock-up attachment, which prevents the regulating parts from being tampered with by evil-disposed persons.

MOVABLE TRIP LEVER.

The trip lever can be easily altered to stand in any direction desired, regardless of the position of the outlet of the valve.

TESTING-CLAMPS.

All valves above 2 inches in size are furnished with testing-clamps when requested, at no extra expense. These are of special benefit when the boilers are tested, obviating the necessity of changing the adjustment of the valve, and preventing an undue strain on the spring.

The Ashton Lock-up Pop Safety Valve.

FOR LARGE STATIONARY AND PORTABLE BOILERS.

Seven Highest Premiums awarded, both Gold and Silver Medals,
also Medals and Highest Awards granted at World's Fair.

No. 3.



INLET.
EXTERIOR VIEW.

Particularly adapted for Boilers for Mills, Factories, Electric Light and Power Plants, Pumping Stations, etc.

This valve has an acknowledged reputation not equalled by any other pop safety valves now on the market. It embodies many valuable patented improvements, including the following:

SPECIAL FEATURES.

BEVEL seats at angle of 45 degrees and of highest-grade composition steam metal. Nickel seats, extra quality, furnished when desired, and at no extra expense. Pop chamber with knife-edge pop lip, which wears evenly with valve seat. Encased spring chamber, protecting spring from steam and forming upper guide for valve. Springs of Jessop's steel wound by hand in our own factory. Pivoted top and bottom disks for spring, to insure a true bearing on valve. Screw plug pop regulator to easily regulate pop from outside without taking valve apart. Movable trip lever, readily changed to stand in any desired position. Lock-up attachment to prevent tampering with adjustment. Working parts of valve entirely of high-grade composition metal. Advantageous construction of inlet and outlet on base casting, not necessitating removal of outlet pipe to grind in or repair valve.

The Ashton Lock-up Pop Safety Valve.

FOR LARGE STATIONARY AND PORTABLE BOILERS.

Adopted by the United States Government, recommended by leading architects and engineers with a record of twenty years' service on all kinds of boilers in every State in the Union.

Valves sent on trial subject to approval if satisfactory.

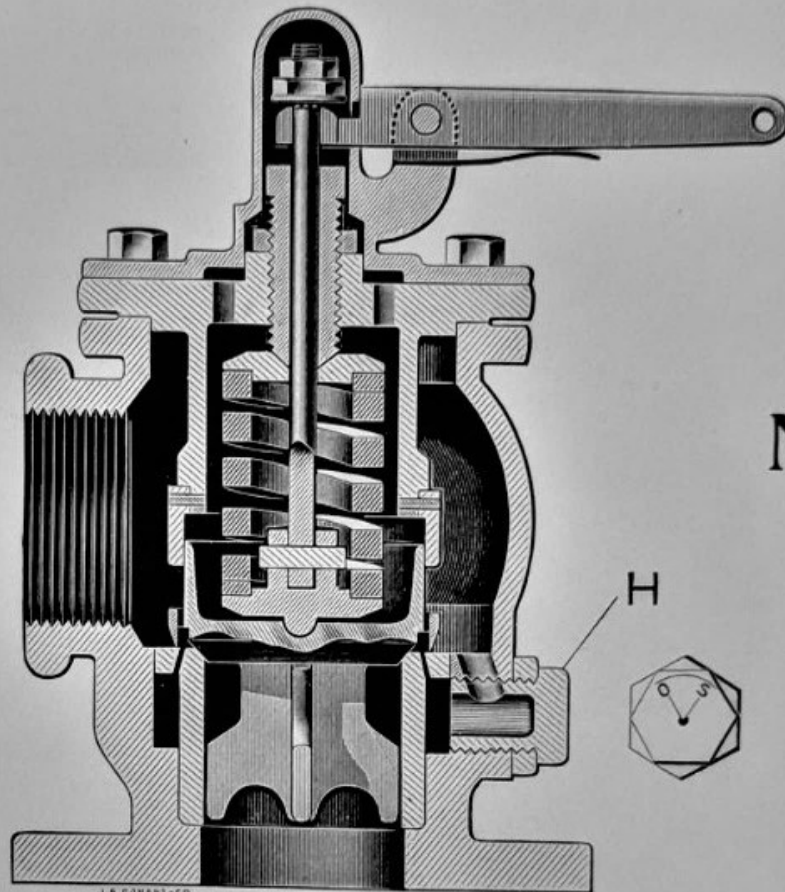

No. 3.

SECTIONAL VIEW.

DIRECTIONS.

TO CHANGE SET PRESSURE unlock padlock and remove lock, pin, and lever. Take off cap by unbolting, thus exposing pressure screw. Slack check nut on screw and turn screw downward for increased pressure or upward for less pressure. Afterwards set up check nut.

TO CHANGE POP, or the difference between the opening and closing of the valve, it is *not necessary* to take the valve apart in any way. This can be accomplished by regulating the patent screw plug pop regulator H on the outside back part of the valve. If more pop is desired, slack the check nut and turn regulator to the left, so that letter S stands nearer perpendicular, or for less pop turn regulator to the right until letter O is nearer perpendicular.

PRICE LIST.

Size Valve . . .	2 in.	2½ in.	3 in.	3½ in.	4 in.	4½ in.	5 in.	5½ in.	6 in.
Price	\$30	\$40	\$55	\$64	\$70	\$80	\$85	\$105	\$125
Diameter of Inlet Flange	7 in.	8 in.	9 in.	10 in.	10 in.	12 in.	12 in.	14 in.	14 in.

Write for Discounts.

When ordering always state highest working pressure.

The Ashton Pop Safety Valves.

FOR SMALL STATIONARY AND PORTABLE BOILERS.

No. 6.



VALVE
WITHOUT
CAP OR
LEVER.

No. 7.



VALVE
WITH
CAP
ONLY.

THESE valves are made of high-grade composition metal, and the springs of Jessop's steel. They give perfect relief, are solid in construction, and durable.

NO. 6 VALVE has patented knife-edge pop lip, encased spring, pivoted disks, and open discharge outlet.

NO. 7 VALVE is similar, but is furnished with top cap to cover and protect pressure screw.

TO CHANGE PRESSURE on these valves, slack check nut and turn pressure screw down for increased pressure or upward for less pressure, then set up check nut. When it is desired to change set pressure more than 15 pounds above or below original set pressure, new springs should be ordered to obtain the greatest efficiency.

PRICE LIST.

Size	¾ in.	1 in.	1¼ in.	1½ in.	2 in.
No. 6 Valve. Price . . .	\$4.50	\$6.50	\$8.50	\$10.00	\$20.00
No. 7 Valve. Price . . .	5.	7.	9.	10.50	20.50

Write for Discounts.

The Ashton Lock-up Pop Safety Valves.

FOR SMALL STATIONARY AND PORTABLE BOILERS.



No. 8.

VALVE
WITH
LOCK-UP,
LEVER,
AND
OPEN
DISCHARGE.



No. 9.

VALVE
WITH
LOCK-UP,
LEVER,
AND
PIPE
OUTLET.

THESE valves are recommended for small-size stationary or portable boilers. They are made throughout of the best composition metal, with the exception of the springs, which are of Jessop's steel; automatic in relief, durable and efficient.

NO. 8 VALVE has lock-up attachment, trip lever, patented knife-edge pop lip, encased spring, pivoted disks, and open discharge outlet.

NO. 9 VALVE is the same as the No. 8 Valve, but with the additional improvement of having pipe outlet.

PRICE LIST.

Size	¾ in.	1 in.	1¼ in.	1½ in.	2 in.
No. 8 Valve. Price	\$6.	\$8.	\$10.	\$12.	\$22.
No. 9 Valve. Price	7.	9.	11.	14.	25.

Write for Discounts.

When ordering always state highest working pressure.

Muffler Attachments.

IN connection with our Stationary and Marine Pop Safety Valves, we are prepared to furnish muffler attachments which can be applied direct to the outlet of the valve or at the end of the outlet pipe. These mufflers effectually muffle the noise of the escaping steam without in any way impairing the efficiency of the valve, being so constructed as to prevent any back pressure whatever.

Prices on application.

Testing=Clamps.

THESSE are furnished with our Stationary and Marine Pop Safety Valves when desired, at no extra expense. They are of special value when boilers are tested, for by their use the Pop Safety Valve does not have to be taken off, nor is it necessary to in any way change the original adjustment of the set pressure of the valve, thus saving the valve spring from excessive and undue strain. The clamps are easily applied, after first removing the valve cap, by placing the ends of the two clamp arms beneath the flange of the valve top and then setting down the clamp screw on to the top of valve stem, thus holding the valve rigidly on its seat. After test is over, remove clamp and replace cap on valve, when it will be found that valve will work perfectly at exactly same pressure as originally set at.

The Ashton Cam Lever Marine Pop Safety Valve.

OUR Marine Pop Valves are extensively used, have exceptional merit, and possess an unequalled reputation. During the past few years a large number of famous American Steamship and Steam Ferry Companies, together with several Foreign Transportation Companies, have adopted the "Ashton" as their standard, in preference to the cheaper class of valves heretofore used.

They have received the official indorsement of the Chief Engineer of the United States Navy, and have been applied to the latest battle-ships, cruisers, and gunboats.

The Ashton Marine Valve embodies all the valuable features of the Ashton "Pop Safety" Valves, described on pages 9, 10, and 11, and in addition has our patent Cam Lever attachment, whereby the valve can be lifted off its seat by hand,—more than the requirement of the government. It is the only valve that conforms promptly, fully, and efficiently to this requirement. (See amended rule 36, page 20.)

The Ashton Noiseless Marine Pop Safety Valve.

BY a special method of application the Standard Ashton Marine Pop Valve, embodying as it does our patent blow-back head, described on page 11, can be made to give perfectly noiseless relief, which feature is of inestimable value in marine service. This special method for accomplishing this greatly desired result is obtained by piping the outlet of the valve down the inside of the hull and out into the water below the surface water-line, where the steam from the valve as it blows off is discharged *noiselessly* and *unseen*. THERE IS POSITIVELY NO BACK PRESSURE on top of the valve.

The Ashton Cam Lever Marine Pop Safety Valve.

WITH LOCK-UP ATTACHMENT.

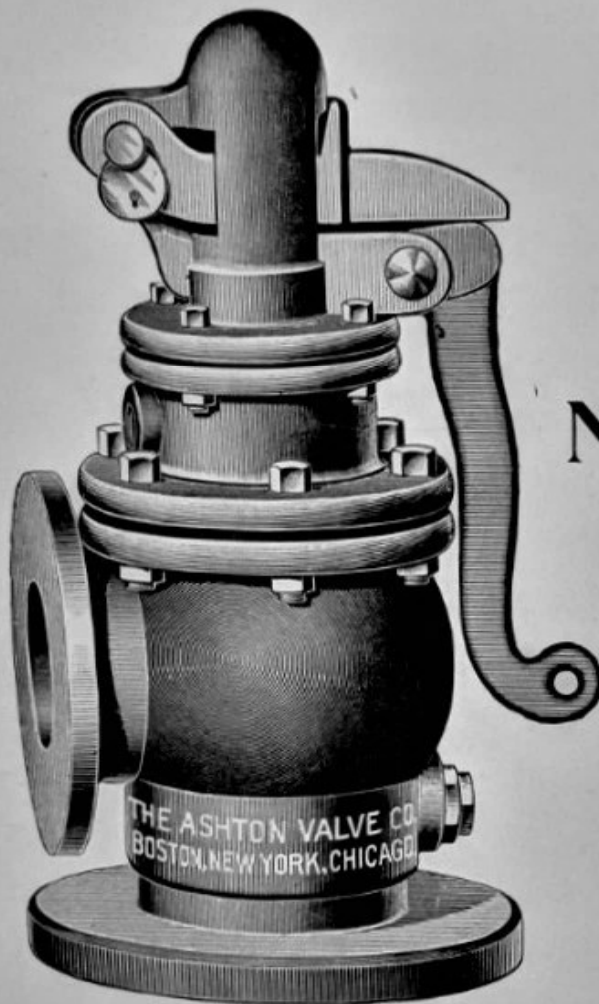

EXTERIOR VIEW.

No. 16.

IRON
MARINE
VALVE.

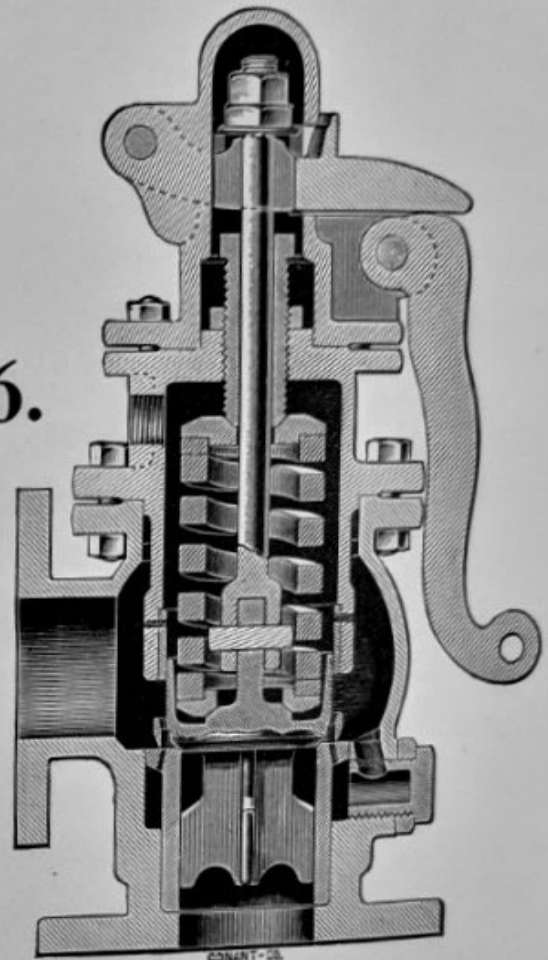

INTERIOR VIEW.

Adopted by the United States Board of Supervising Inspectors of Steam Vessels. Approved and accepted by the United States Navy Department.

THIS valve is especially adapted for marine service on steamships, towboats, steam yachts, etc., and is the standard valve on many of the large steamship lines. It is in use on several of the latest United States battle-ships, cruisers, and gunboats, having been accepted by the Chief Engineer of the United States Navy.

The several advantages in the Ashton Cam Lever Marine Pop Valve, as explained on page 17, show conclusively the superiority of the valve, and give it the high reputation it possesses.

Unless otherwise stated, all marine valves above 2-inch size are made with flanged inlet and outlet.

Testing-clamps for these valves furnished at no extra expense. as every

The Ashton Cam Lever Marine Pop Safety Valve.

WITH LOCK-UP ATTACHMENT.

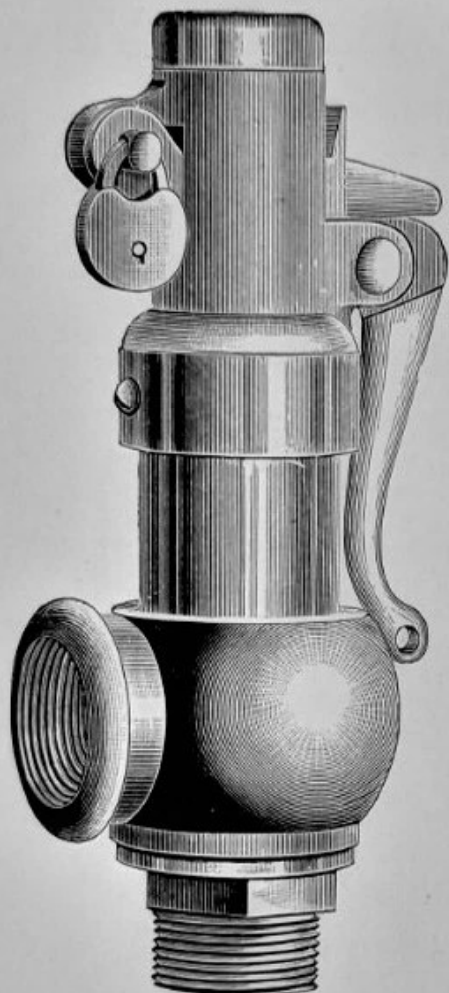

EXTERIOR VIEW.

No. 15.

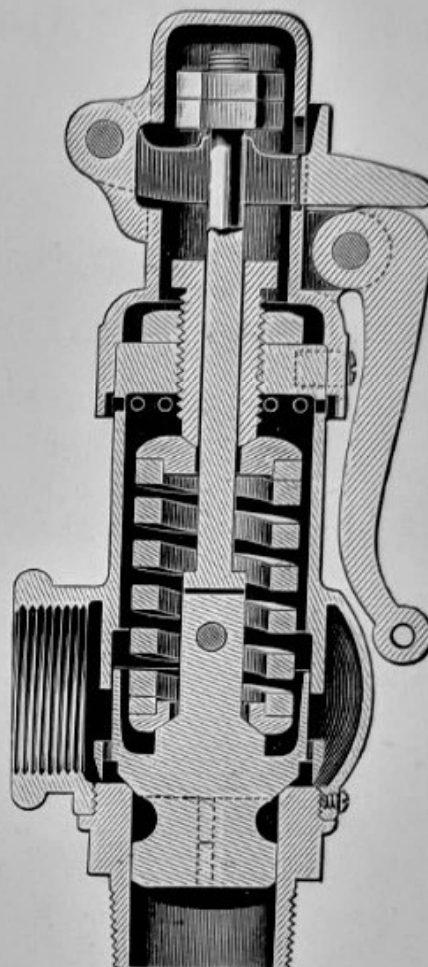

CONANT-CO BOSTON
INTERIOR VIEW.

YACHT VALVE.

THIS valve is made of composition metal, finely finished, in sizes from $\frac{3}{4}$ in. to $2\frac{1}{2}$ ins., inclusive, and is recommended more especially for steam yachts. It has bevel seat, encased spring, cam lever lifting-attachment, and fully complies with the rules and regulations of the United States Board of Supervising Inspectors of Steam Vessels. The valve has pipe outlet, so that the steam discharge may be carried outside boiler-room.

PRICE LIST.

Size	$\frac{3}{4}$	1	$1\frac{1}{4}$	$1\frac{1}{2}$	2	$2\frac{1}{2}$	3	$3\frac{1}{2}$	4	$4\frac{1}{2}$	5	$5\frac{1}{2}$	6
No. 15 Composition Valve	\$7.20	\$9.60	\$12.	\$14.40	\$25.	\$40.							
No. 16 Iron Valve						48.	\$66.	\$75.	\$84.	\$95.	\$102.	\$125.	\$150.
Inlet Flange, inches						8	9	10	10	12	12	14	14
Outlet Flange, inches						7	$7\frac{1}{2}$	8	$8\frac{1}{2}$	9	$9\frac{1}{2}$	10	$10\frac{1}{2}$

Write for Discounts.

“Nickel Seated” Valves at prices same as above.

Testing-clamps furnished at no extra expense.

Always order by number of valve, give pressure to set valve, and state whether flanged or screw end is desired.

The sectional interior views show the several valuable features contained

The Ashton Cam Lever Marine Pop Safety Valve.

ACCORDING to the amended Rule 36 of the United States Board of Supervising Inspectors of Steam Vessels, at their annual meeting, March, 1884, the following size Ashton Pop Safety Valves are required for boilers having grate surfaces as below:

	$\frac{3}{4}$ inch	Pop Valve for	1.32 square feet of grate surface.			
1	"	"	"	2.35	"	"
$1\frac{1}{4}$	inches	"	"	3.67	"	"
$1\frac{1}{2}$	"	"	"	5.30	"	"
2	"	"	"	9.42	"	"
$2\frac{1}{2}$	"	"	"	14.72	"	"
3	"	"	"	21.20	"	"
$3\frac{1}{2}$	"	"	"	28.86	"	"
4	"	"	"	37.69	"	"
$4\frac{1}{2}$	"	"	"	47.71	"	"
5	"	"	"	58.90	"	"
$5\frac{1}{2}$	"	"	"	71.27	"	"
6	"	"	"	84.82	"	"

The Ashton Marine Valve has bevelled seats at an angle of 45 degrees; and the Cam Lever on all of them is made to lift the valve off its seat one-eighth the diameter of the valve opening, as required by the rules and regulations of the United States Board of Supervising Inspectors of Steam Vessels at their annual

The Ashton

Cam Lever Marine Pop Safety Valves.

AREAS OF CIRCLES from which can be computed the proper size of Ashton Pop Safety Valves to conform to Rule 36 of the United States Board of Supervising Inspectors of Steam Vessels.

RULE. — One square inch valve area for every three square feet of grate surface.

DIAM. Inches.	AREA. Sq. Inches.	DIAM. Inches.	AREA. Sq. Inches.	DIAM. Inches.	AREA. Sq. Inches.	DIAM. Inches.	AREA. Sq. Inches.
1/64	.000192	4	12.5664	1/8	65.3968	1/4	159.485
1/32	.000767	1/8	13.3641	1/4	67.2008	3/8	162.296
1/16	.003068	1/4	14.1863	3/8	69.0293	1/2	165.13
1/8	.012272	3/8	15.033	1/2	70.8823	5/8	167.99
3/16	.027612	1/2	15.9043	5/8	72.7599	3/4	170.874
1/4	.049087	5/8	16.8002	3/4	74.6621	7/8	173.782
5/16	.076699	3/4	17.7206	7/8	76.5888	15	176.715
3/8	.110447	7/8	18.6655	10	78.54	1/8	179.673
7/16	.15033	5	19.635	1/8	80.5158	1/4	182.655
1/2	.19635	1/8	20.629	1/4	82.5161	3/8	185.661
9/16	.248505	1/4	21.6476	3/8	84.5409	1/2	188.692
5/8	.306796	3/8	22.6907	1/2	86.5903	5/8	191.748
11/16	.371224	1/2	23.7583	5/8	88.6643	3/4	194.828
3/4	.441787	5/8	24.8505	3/4	90.7628	7/8	197.933
13/16	.518487	3/4	25.9673	7/8	92.8858	16	201.062
7/8	.601322	7/8	27.1086	11	95.0334	1/8	204.216
15/16	.690292	6	28.2744	1/8	97.2055	1/4	207.395
1	.7854	1/8	29.4648	1/4	99.4022	3/8	210.598
1/8	.99402	1/4	30.6797	3/8	101.6234	1/2	213.825
1/4	1.2272	3/8	31.9191	1/2	103.8691	5/8	217.077
3/8	1.4849	1/2	33.1831	5/8	106.1394	3/4	220.354
1/2	1.7671	5/8	34.4717	3/4	108.4343	7/8	223.655
5/8	2.0739	3/4	35.7848	7/8	110.7537	17	226.981
3/4	2.4053	7/8	37.1224	12	113.098	1/8	230.331
7/8	2.7612	7	38.4846	1/8	115.466	1/4	233.706
2	3.1416	1/8	39.8713	1/4	117.859	3/8	237.105
1/8	3.5466	1/4	41.2826	3/8	120.277	1/2	240.529
1/4	3.9761	3/8	42.7184	1/2	122.719	5/8	243.977
3/8	4.4301	1/2	44.1787	5/8	125.185	3/4	247.45
1/2	4.9087	5/8	45.6636	3/4	127.677	7/8	250.948
5/8	5.4119	3/4	47.1731	7/8	130.192	18	254.47
3/4	5.9396	7/8	48.7071	13	132.733	1/8	258.016
7/8	6.4918	8	50.2656	1/8	135.297	1/4	261.587
3	7.0686	1/8	51.8487	1/4	137.887	3/8	265.183
1/8	7.6699	1/4	53.4563	3/8	140.501	1/2	268.803
1/4	8.2958	3/8	55.0884	1/2	143.139	5/8	272.448
3/8	8.9462	1/2	56.7451	5/8	145.802	3/4	276.117
1/2	9.6211	5/8	58.4264	3/4	148.49	7/8	279.811
5/8	10.3206	3/4	60.1322	7/8	151.202	19	283.529
3/4	11.0447	7/8	61.8625	14	153.938	1/8	287.272
7/8	11.7933	9	63.6174	1/8	156.7	1/4	291.04

Instruction. — Ascertain area of grate surface in square feet; divide this amount by three; the answer will be the number of square *inches* valve area required. Refer to table above. Against this amount will be *size* of valve required.

The Ashton Water Relief Valve.

STANDARD UNDERWRITER PATTERN.

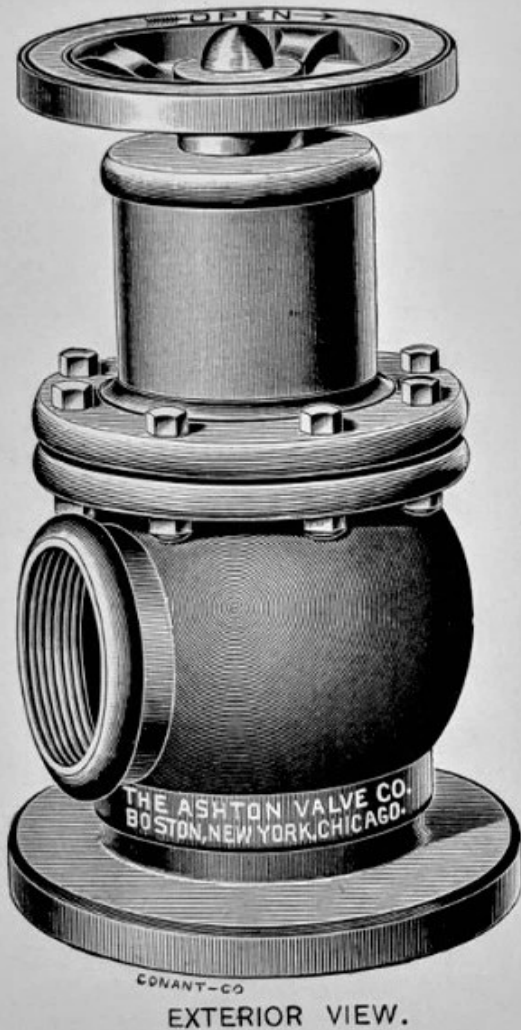

EXTERIOR VIEW.

No. 22.

IRON WATER
RELIEF VALVE.

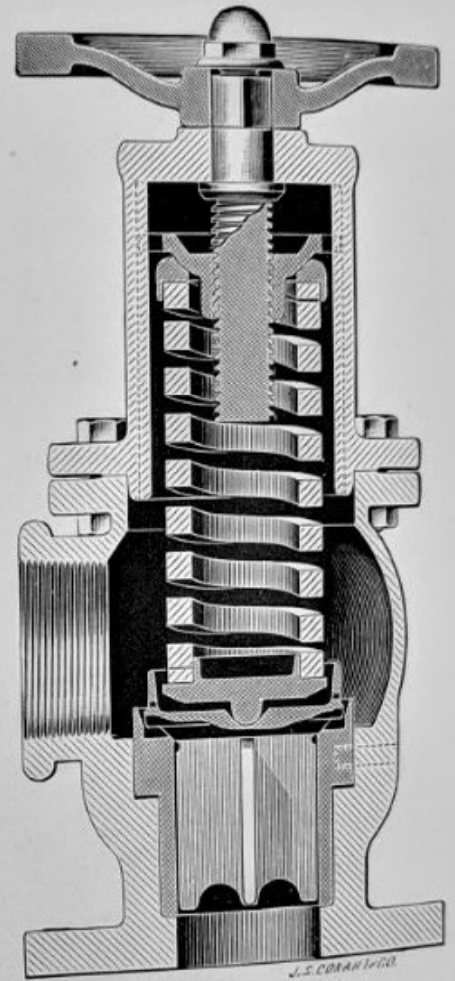

INTERIOR VIEW.

For Fire Pumps, Hydraulic Elevators, Water Works, Pumping Stations, and Stand Pipes, and wherever an automatic relief valve is wanted to prevent a water hammer or over pressure of water. These valves are largely used in mills in connection with the fire pump, and will positively prevent bursting of hose or pipe.

OUR No. 22 style is termed the Underwriters' Pattern, having been comparatively tested and accepted by the Associated Factory Insurance Companies, and given first mention in their Underwriters' Pump Specifications. Greatest efficiency and durability, combined with ease of adjustment, are the main points that have brought this valve into such extensive use.

As shown in the sectional *interior* view, this valve is made of a large pattern, with extra-long spring, giving large relief. It is furnished with large wheel-top for easy adjustment. The working parts are of high-grade composition metal, to prevent corrosion; the spring, of Jessop's steel.

For prices, see opposite page.

DIRECTIONS.

To change and *increase* relief pressure, turn wheel on top of valve from left to right. It will be "Valves

The Ashton Water Relief Valve.

SMALL COMPOSITION PATTERN.



No. 24.

THIS valve is adapted for similar purposes to which No. 22 Valve is applied, only on a smaller scale. It is made in sizes from $\frac{3}{4}$ in. to $2\frac{1}{2}$ ins., inclusive, and is entirely of composition metal, finely finished, the spring of Jessop's steel.

ADJUSTMENT OF WATER RELIEF VALVES.—To increase pressure of No. 22 Iron Water Relief Valve, turn wheel from right to left. For No. 24 Composition Valve, turn from left to right.

PRICE LIST.—WATER RELIEF VALVES.

Size	$\frac{3}{4}$	1	$1\frac{1}{4}$	$1\frac{1}{2}$	2	$2\frac{1}{2}$
No. 24, Price	\$7.	\$9.	\$12.50	\$16.50	\$23.	\$40.
No. 22, Price	30.	40.	60.
Inlet Flange, inches	8
Size	3	$3\frac{1}{2}$	4	$4\frac{1}{4}$	5	6
No. 24, Price	\$65.					
No. 22, Price	75.	\$80.	\$85.	\$105.	\$125.	\$150.
Inlet Flange, inches	9	10	10	12	12	14

Write for Discounts.

In ordering, always state pressure at which valve is to relieve.

The Ashton Hydraulic Relief Valve.

FOR EXTREME HIGH-PRESSURE SERVICE.

OUR hydraulic valves are made in all sizes, to suit any pressure, and are extensively used on hydraulic presses and pumps, or wherever an automatic high-pressure relief is required. They are solidly constructed, of material of great tensile strength, and so made that they can be taken apart to grind in the seat, without breaking inlet or outlet connections.

In sizes up to and including three inches, they are usually made of high-grade composition metal, with springs of Jessop's steel.

In ordering, always state size of valve wanted, and pressure at which it is to relieve.

Prices will be given on application, in which case always mention highest working pressure carried.



No. 25.

The Ashton Cylinder Relief Valve.

No. 10.

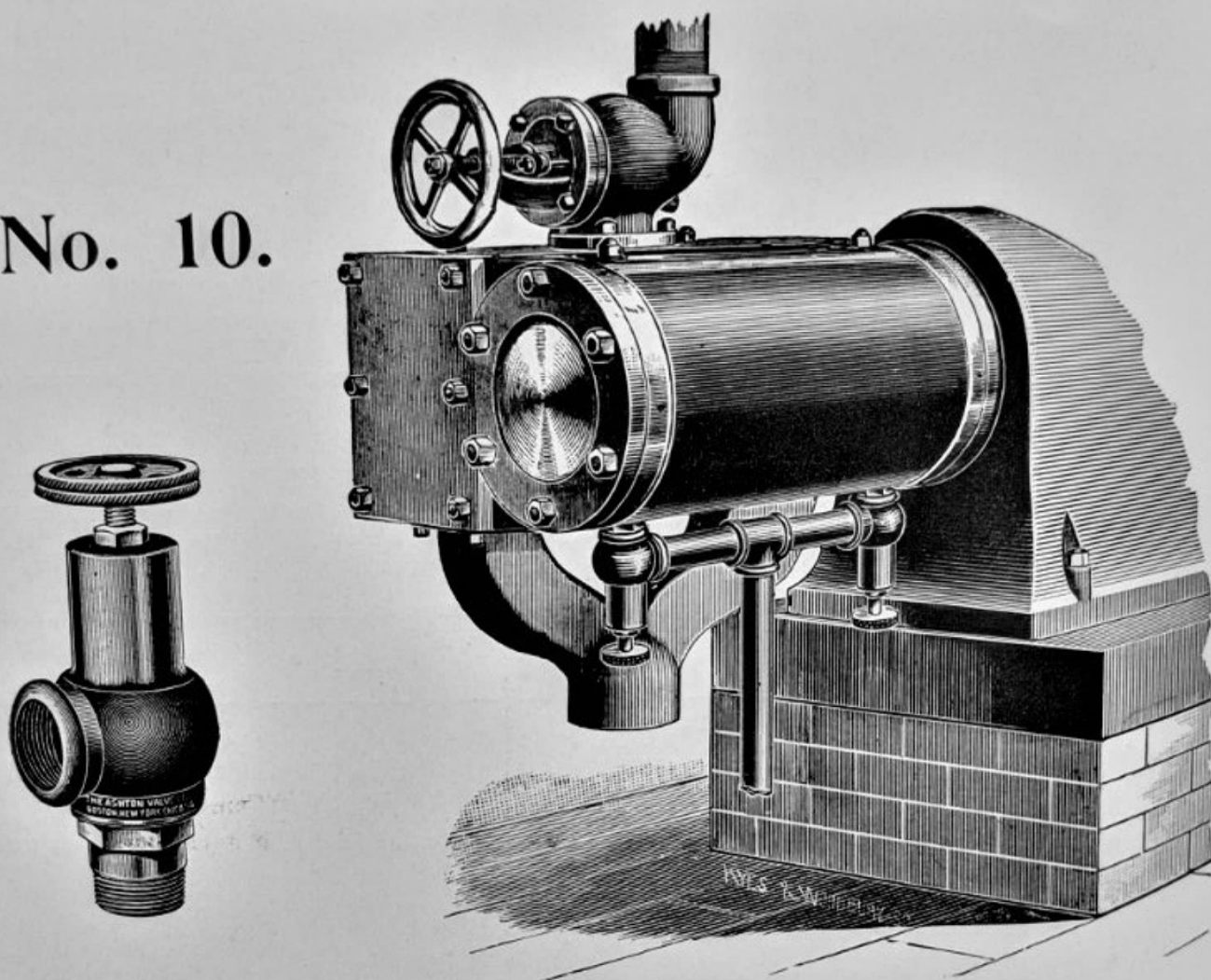

WITH an Ashton Cylinder Relief Valve of sufficient size applied to each end of a steam-engine cylinder, perfect safety is assured. No danger of blowing cylinder heads out or doing other damage by the accumulation of water in the cylinder. This valve is provided with wheel top, so that the set pressure can readily be changed as desired. When specially requested, these valves are made with side connection on bottom part for indicator attachment.

In ordering, state highest pressure; the usual custom being to set the valves to relieve at from 10 to 15 lbs. higher than highest working pressure.

This valve made of composition metal finely finished throughout with Jessop's steel springs.

PRICE LIST.

2 1/2 in.

The Ashton Snifting Relief Valve.



No. 18.

THIS Snifting Valve is used on cylinders, condensers, or in any place where a quick-working relief valve is needed. It is made of composition metal with pipe outlet, and similar in construction to the No. 10 Valve shown on opposite page.

As shown in the above cut, this valve is quite commonly made with extra side-pipe connection on bottom part for indicator attachment. This is not furnished, however, unless specified on the order.

Always give highest working pressure when ordering.

PRICE LIST.

Size . . .	3/4 in.	1 in.	1 1/4 in.	1 1/2 in.	2 in.	2 1/2 in.
Price . . .	\$7.00	\$9.00	\$12.50	\$16.50	\$23.00	\$40.00

The Ashton Improved Car Heater Valve.

No. 14.

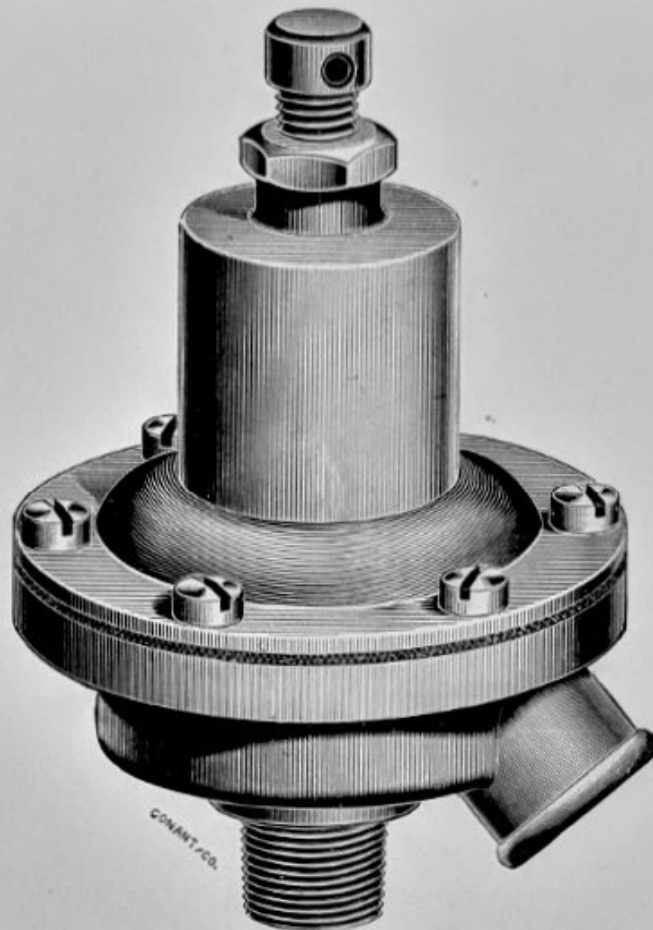

EXTERIOR VIEW.

THIS valve is designed as a Safety Valve for Car Heaters. When in operation, the steam is discharged *downwards under the car.*

Enormous damage has been done to Pullman and other passenger cars by the defacement of their finished outside surfaces, and to the tin roofs, by the salt brine spattered over them when the valves in ordinary use blow off steam. The salt water corrodes and eats into the metal roofs, and destroys the varnish of the cars.

Our Car Heater Valve has an outlet which is piped to convey the discharge to the track. It is a perfect pop valve, and the attention of all car-building departments is called to it.

The valve has no wings extending into the inlet to become fouled or clogged up with the salt crystals. The composition metal of which these valves are made stands the chemical tests for salt and vegetable acids. The valves cannot corrode, or stick, or get out of order, like the old-style rubber-ball valves now in

The Ashton Improved Locomotive Muffler Pop Safety Valve.

OUR MUFFLER PATENTS.

June 3, 1884.
Dec. 13, 1892.
Apr. 25, 1893.
June 6, 1893.
Apr. 2, 1895.

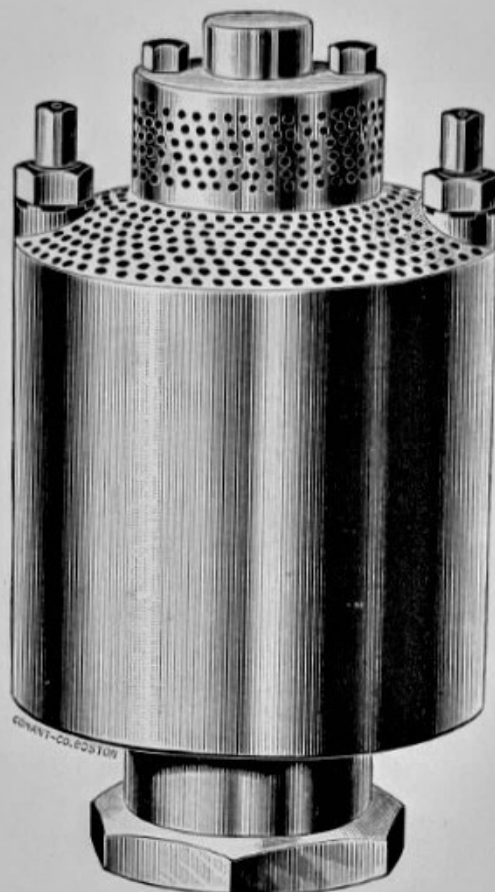

No. 30.

The only Muffler made having top outside adjustment for regulating the Pop; saves time and expense, increases efficiency and durability. Our Muffler patents control the only method of regulating the Pop without taking Valve apart or removing it from the locomotive.

EVER since the introduction of our first muffler valve some ten years ago, there has been a remarkably increasing interest among the railroads in adopting this style valve, until now it is by far the valve in greatest demand. The quiet yet efficient relief given by the muffler in contrast with the noisy open pop valve is universally appreciated, and railroads are fast adopting muffler valves for the working valves on their engines. In some States the law requires the use of them on all locomotives.

Ashton Improved Muffler Valves are guaranteed to give unequalled efficiency and durability, showing lowest cost for repairs.

SPECIAL NOTICE.

Our Locomotive Pop Safety Valves are not made in sizes larger than three inches, as we guarantee our 3-inch muffler or 3-inch open pop to give perfect relief to any locomotive boiler in the world.

The Ashton Improved Locomotive Muffler Pop Safety Valve.

No. 30.

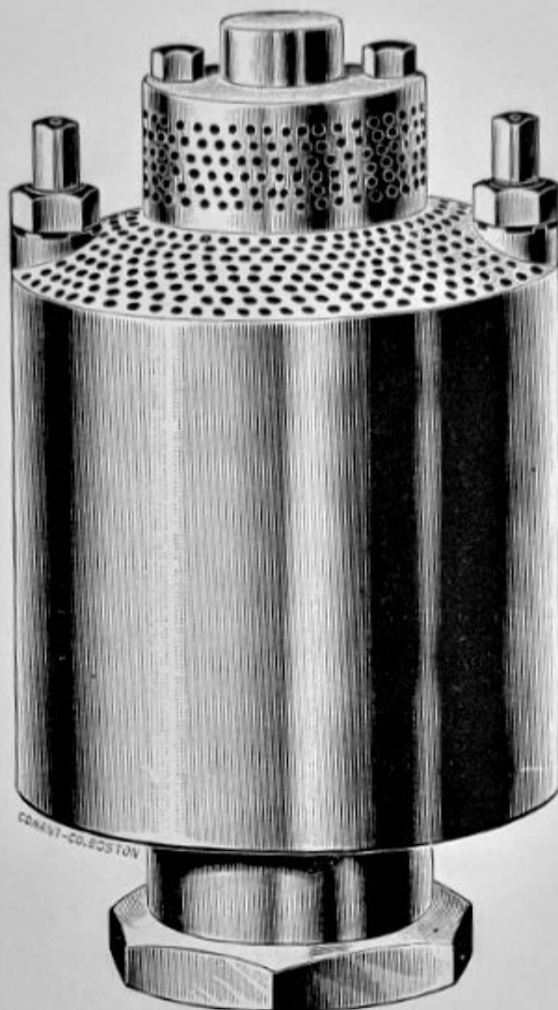

For instructions
how to adjust
valves, see
opposite page.

Made in sizes $2\frac{1}{2}$ inches, $2\frac{3}{4}$ inches, and 3 inches.

DURING the past year valuable improvements have been made to our Locomotive Muffler Pop Safety Valves, patent for which has been granted to us under date of April 2, 1895, and we would especially call the attention of our railroad friends and prospective customers to the several practical advantages over the former style and over any other make now on the market. In railroad practice it is well known that to get the greatest efficiency and durability from pop safety valves, the pop (or difference between the opening and closing pressures) should be occasionally regulated, as for instance shortly after the valve has been put into use and got down to good working order, and also after having been repaired, or in case the spring has materially lightened up. Heretofore, means have been provided for making this necessary regulation of the pop, but until now no thoroughly practical way has been devised to accomplish the desired result without taking the valve apart and changing the set pressure or else removing it from the locomotive. Our new patent, however, embodies a form of regulation adjustable from the outside top part of the muffler casing, is always accessible, does not require the valve to be taken apart or to be removed from the engine. All that it is necessary to do is to turn either or both of the two regulating posts marked 2 and 3, shown in the sectional cut, to the right or left, according to whether the pop is desired to be more or less, and this regulation can all be done while steam is on the boiler and the locomotive in service. This gives a great durability to the pop safety valve.

The Ashton Improved Locomotive Muffler Pop Safety Valve.

Locomotive Valves sent on trial subject to approval if satisfactory; can be returned at our expense if found otherwise.

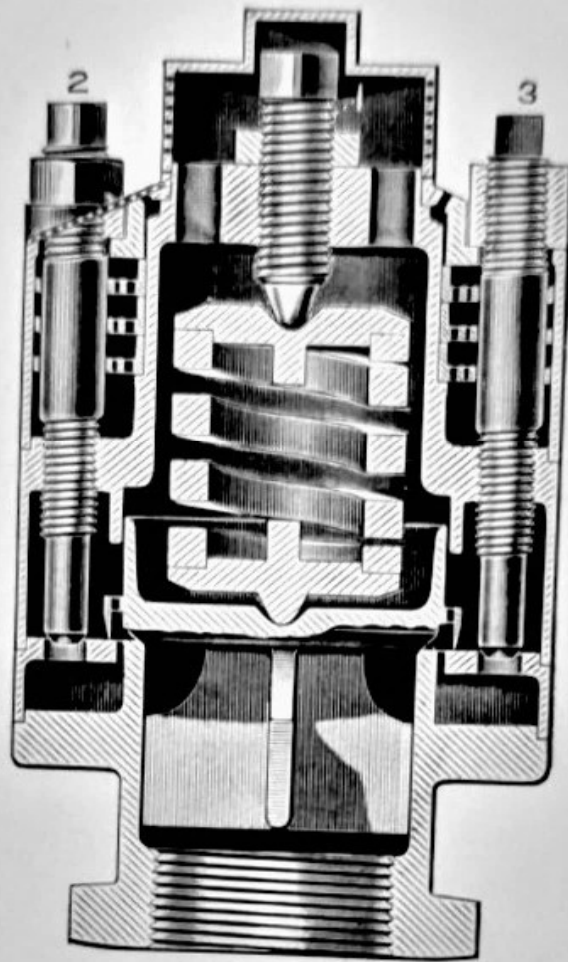

No. 30.

SECTIONAL VIEW.

PRICE LIST.

Size,	2½ inches.	2¾ inches.	3 inches.
Price,	\$85.00	\$90.00	\$95.00

Write for Discounts.

DIRECTIONS.

TO CHANGE POP, slack check-nut on either one or both of the top regulators (numbered 2 and 3), and screw down for increased pop, or contrary for less pop.

TO CHANGE SET PRESSURE, first unbolt and remove top cap, thus exposing the pressure-screw; then slack check-nut, and turn pressure-screw (marked 1) down for increased or upward for less pressure; afterwards set up check-nuts.

PLEASE NOTE FOLLOWING SUGGESTIONS.

Our Pop Safety Valves are set at our works at the required pressure; but if, after being in use a few days, they should blow off at a slightly lower pressure (as is likely to be the case with any new valve), please see that the pressure is set back promptly to the original pressure again. If allowed to run light, it causes the valve to remain open, which is injurious to its interior.

Boston *London*

The Ashton Locomotive Open Pop Safety Valve.

No. 28.

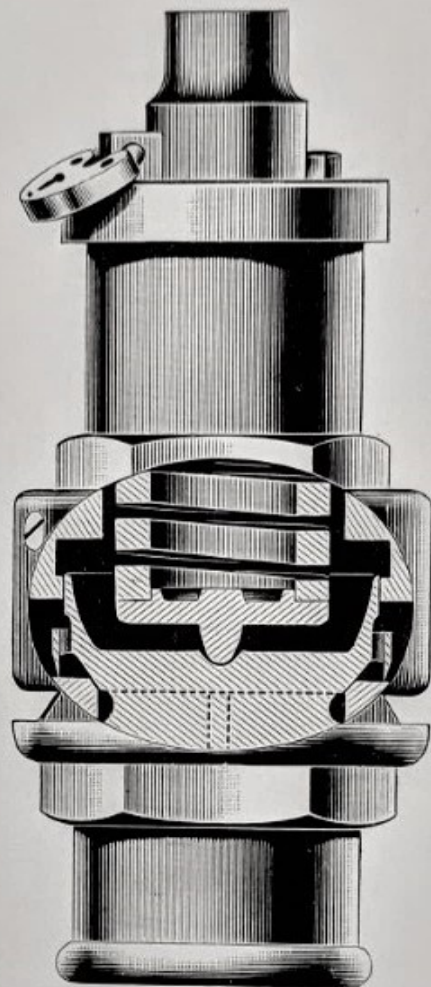

Directions for changing adjustment on opposite page.

Made in sizes $2\frac{1}{2}$ inches and 3 inches.

THE Ashton Open Pop Valve stands without a peer in points of construction, efficiency, and durability. No other open pop valve holds an equal reputation on the railroads of this country.

It is the only valve of its kind made with the following important improvements:

Knife-edge pop lip wearing evenly with the valve seat, giving an unvarying pop.

Encased spring chamber forming an upper guide for the valve above the seat, and enclosing the spring, thus protecting it from the great volume of steam, making its life so much longer.

Downward discharge outlet so arranged that cinders will not get into the valve to clog it.

Spring made of Jessop's unequalled cast steel.

Price 21/6

The Ashton Cam Lever Locomotive Open Pop Safety Valve.

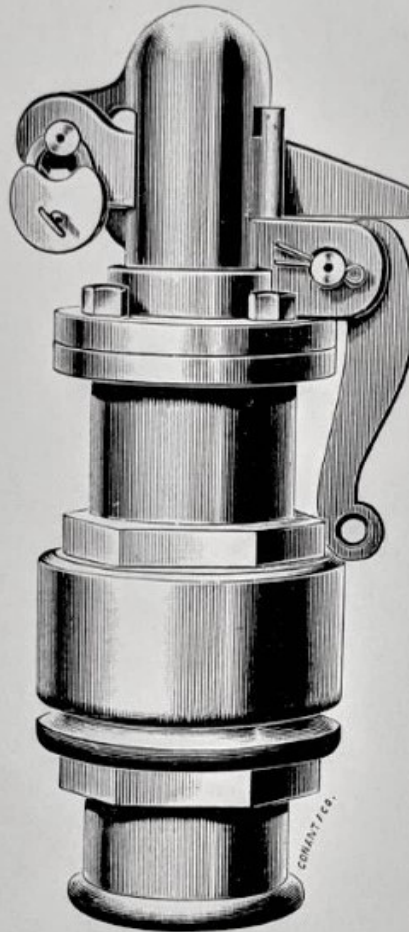

No. 29.

Made in sizes 2½ inches and 3 inches.

OUR Cam Lever Open Pop Valve, as above shown, is virtually the No. 28 Valve described on the opposite page, with the addition of the Cam Lever attachment on top. This valve is oftentimes used on locomotives as an auxiliary to the No. 28 Open Pop or No. 30 Muffler Valve. In such cases this Cam Lever Valve is usually set to work at a few pounds higher pressure. The Cam Lever makes it possible to trip the valve easily by hand, or by means of a rod attached to the lever it is possible to trip the valve from the cab.

DIRECTIONS.

TO CHANGE SET PRESSURE. Unlock and remove top cap, exposing pressure screw. Slacken check nut on screw and turn screw to right for more pressure, or vice versa.

TO CHANGE POP. If less pop is desired, drill a few additional holes on top of valve lip; or if more pop is wanted, plug up some of the holes.

Price, 2½ inch, \$45.00; 3 inch, \$55.00.

Write for Discounts

The Ashton Noiseless Blow-Back Pop Safety Valves, for Locomotives.

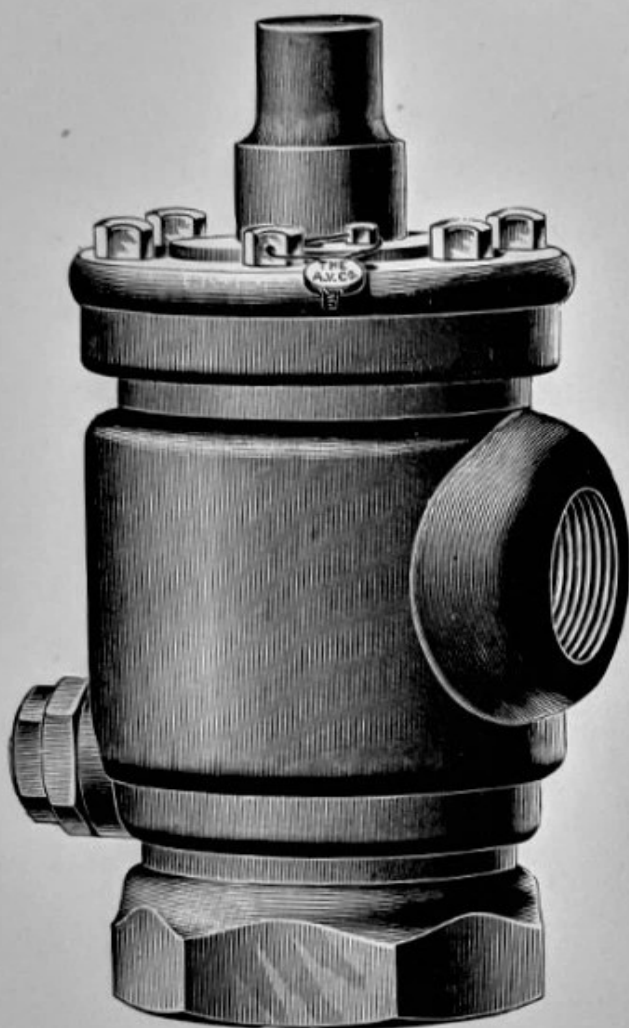

EXTERIOR VIEW.

No. 27.

BLOW-BACK
VALVE.

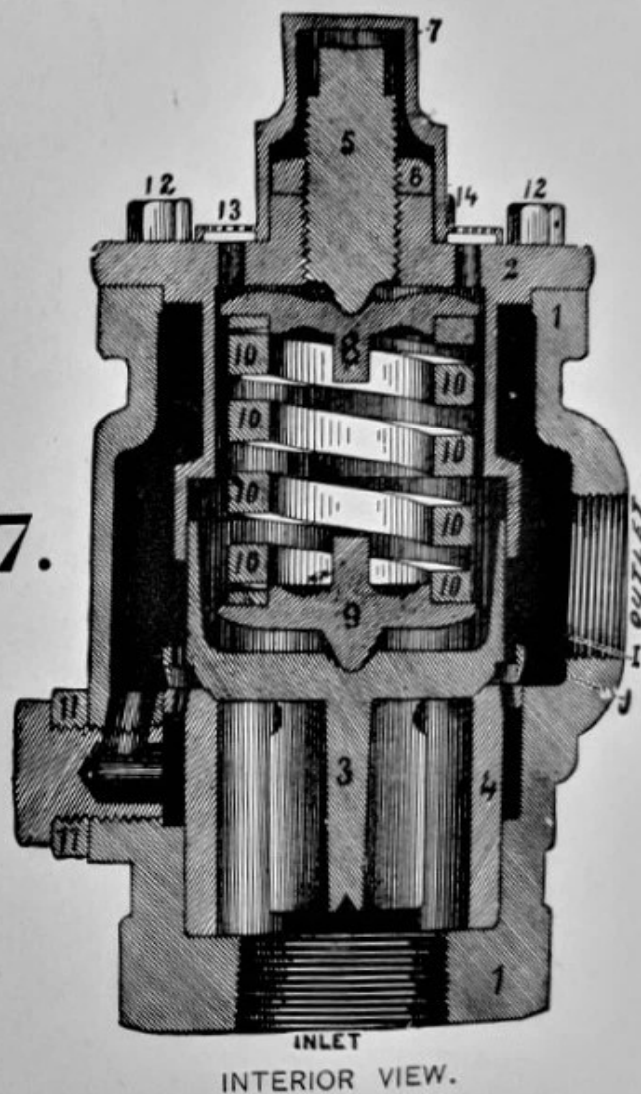

INLET
INTERIOR VIEW.

Made in sizes $2\frac{3}{4}$ inches and 3 inches.

THE only noiseless system of boiler relief known. It stops the noise. Saves what was wasted. It utilizes the steam by heating the feed-water. The escaping steam is not seen or heard. It induces carefulness and economy to both engineer and fireman. It lessens the scaling of boilers.

On heavy grades a locomotive will make time, where it failed to do so without the valve. It is the best safety valve made; it cannot stick or corrode on its seat, and relieves the boiler instantly, with only a slight reduction of steam. All other "pop" valves, by continued use, change their pop and blow down steam; *ours does not.*

We offer to apply one without cost to any railroad, and leave it to demonstrate its value, and then take

The Ashton Noiseless Locomotive Blow-Back Pop Safety Valve.



THE above cut illustrates the usual way of piping the discharge from the Blow-Back Valve to the feed-water in the tender. It is equally applicable to pipe the valve into the smoke-arch or direct to a muffler, though a saving of fuel is effected only when piped to the tank as a feed-water heater.

List of fittings to be used in applying the Ashton Noiseless Blow-Back Safety Valve to locomotives :

- | | |
|---|---|
| <p>35 to 40 feet 1½-inch Pipe
(furnished by railroad).</p> <p>1 Brass Offset
(according to build of engine).</p> <p>1 Bent Pipe (for dome).</p> <p>1 Distributor (for tender).</p> <p>1 Pair Hose Clamps.</p> <p>1 Set Hose Connections</p> | <p>3 feet 4-ply Hose.</p> <p>6 Elbows, 1½-inch, malleable.</p> <p>2 Unions, 1½-inch, malleable.</p> <p>2 Lock-nuts, 1½-inch, malleable.</p> <p>1 2-inch extra heavy Nipple.</p> <p>1 Nipple, 1½-inch, 4 inches long.</p> <p>1 Nipple, 1½-inch, 10 inches long.</p> <p>1 ¼-inch Pet Cock (brass)</p> |
|---|---|

Pop Safety Valve Springs.

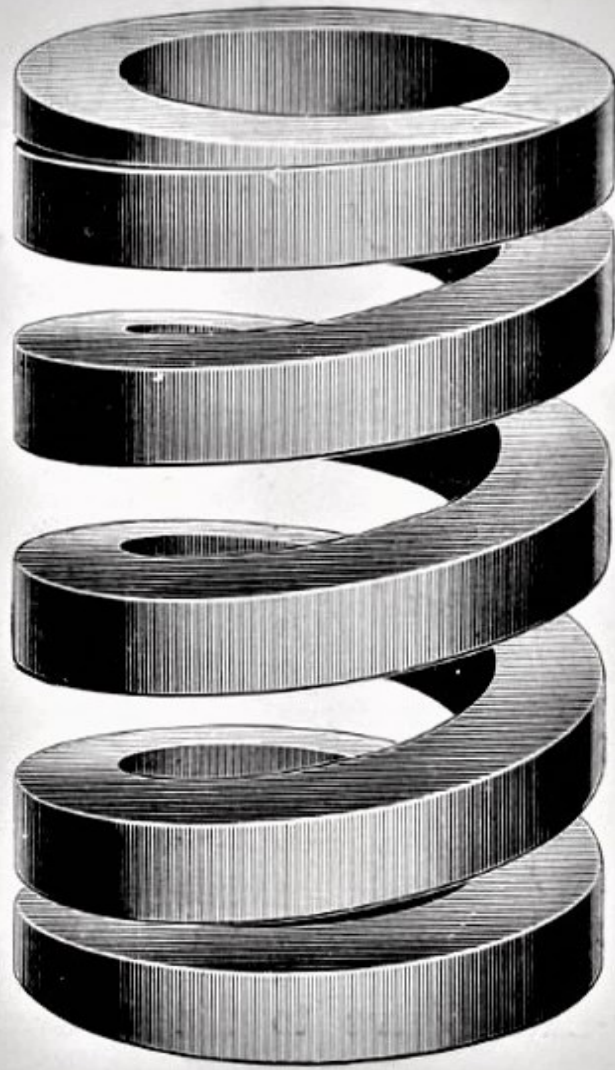

ALL the springs used in the Ashton Pop Safety Valves are manufactured at our own works, of the highest quality of cast steel; Jessop's steel, as imported from Sheffield, England, being used exclusively. Each spring is made and tempered separately, so that every part comes directly under the eyes of the workmen. They are ground square and true on the ends, and afterwards tested to stand at least double the strain that they will ever be put to in actual service.

The life of a Pop Safety Valve is in its spring.

SPECIAL SPRINGS.

We manufacture coil springs of various materials and sizes, and

Hartford Statistics.

FIGURES furnished by the Hartford Steam Boiler Inspection and Insurance Company, Hartford, Conn., from the reports to them from their inspectors among the various steam plants in the country. Look at the results:

YEAR.	Safety Valves Overloaded.		Safety Valves Defective in Construction.	
	Whole No.	Dangerous.	Whole No.	Dangerous.
1883	407	176	367	163
1884	327	129	440	171
1885	363	149	522	173
1886	311	135	448	132
1887	433	139	423	146
1888	473	146	542	176
1889	542	167	713	221
1890	535	159	795	254
1891	675	193	804	242
1892	701	210	947	301
1893	723	203	942	300
1894	835	267	1,159	378
1895	954	270	1,209	369

From organization of the Company to January, 1896:
 Total number of safety valves found overloaded 7,279
 Total number of safety valves defective in construction 9,311
 Total number of safety valves found to be in a *dangerous*
 condition 5,369

MORAL. — Use the Ashton Lock-up Pop Safety Valves, that cannot be tampered with or overloaded, and the construction of which is the most simple, durable, and reliable of any made. The Ashton fills the bill.

The Ashton Improved Pressure and Vacuum Gages.

GENERAL DESCRIPTION.

OUR gages are carefully and conscientiously made, and are the product of the best of material and skilled labor combined. Their reputation is second to none, and we warrant them to be superior in quality, durability, and accuracy. They are made with solid drawn-brass seamless tubes. The movements are non-corrosive, having German silver pinions and arbors. Every dial is marked up separately and accurately to exactly match the mechanism of the gage on which it is used, and the letters and figures are plainly indented so they can be easily read and will not wear off. When desired, name is marked on dials at no extra expense. A siphon must invariably be used on all steam gages, so that nothing but water will enter the gage.

The Ashton Patent Steam Gage.

No. 50.

THIS gage embodies the most valuable improvement made in gages in recent years. No gage now on the market to our knowledge equals it. It is the only gage that will not continually deteriorate by the setting of the tube, and will therefore commend itself to the trade as the most durable and reliable gage now offered for sale. Our Patent Gage is made somewhat after the old Bourdon Gage principle, but with the valuable and essential patented improvement of the addition of a tempered-steel coil spring attached to the ordinary brass tube and to the top interior part of the gage case. The important function of the steel coil spring is to counteract the natural tendency of the tube to set, and to invariably make the tube return to its original curvature and position, bringing the hand back to the pin, always, when the steam pressure is released. This important feature is of great value where

The Ashton Patent Steam Gage.

Patented Jan. 27, 1891.

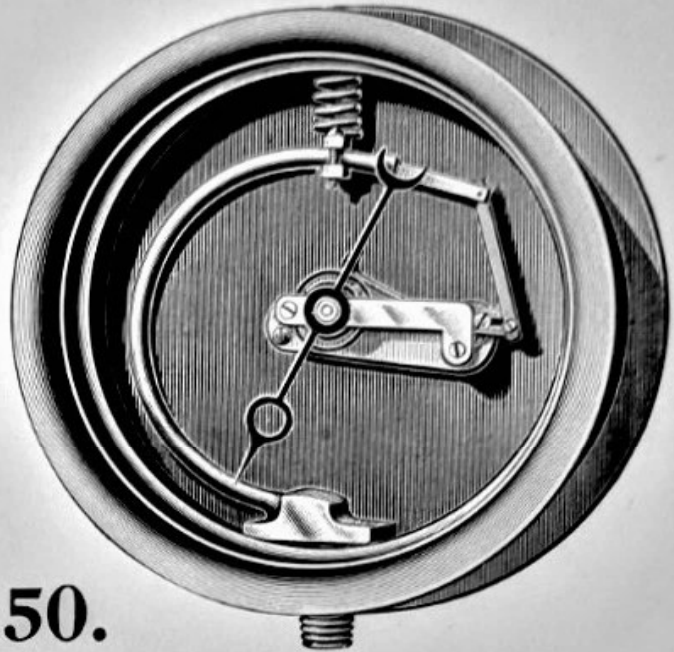

No. 50.

Superior to all Others.

See opposite page for description.

ESPECIALLY adapted for locomotives, portable, traction, and steam fire-engines.

Non-setting. Non-freezing. Non-corrosive. Accurate and reliable.

PRICES, INCLUDING COCK.

SIZE.	Iron Case Japanned.	Iron Case N. P. Ring.	Brass Case.	N. P. Case.	Brass Deep Case O. G. or Oct. Ring.	N. P. Deep Case O. G. or Oct. Ring.
12-inch Dial . .	\$55.00	\$56.50	\$80.00	\$84.00	\$85.00	\$89.00
10 " . .	37.00	38.00	45.00	48.00	49.00	52.00
8½ " . .	25.00	25.75	34.00	36.50	37.50	40.00
6¾ " . .	18.00	18.60	22.00	24.00	25.00	27.00
6 " . .	15.00	15.50	18.00	19.50		
5½ " . .	12.00	12.25	14.00	15.25		
5 " . .	11.00	11.20	13.00	14.00		
4½ " . .	10.00	10.20	12.00	13.00		

Write for Discounts.

All Ashton Patent Gages made with solid drawn-brass seamless tube. Movements provided with German-silver pinions and arbors, which do not corrode.

No gage warranted unless connected by a siphon

The Ashton Improved Single Spring Bourdon Steam and Pressure Gages.

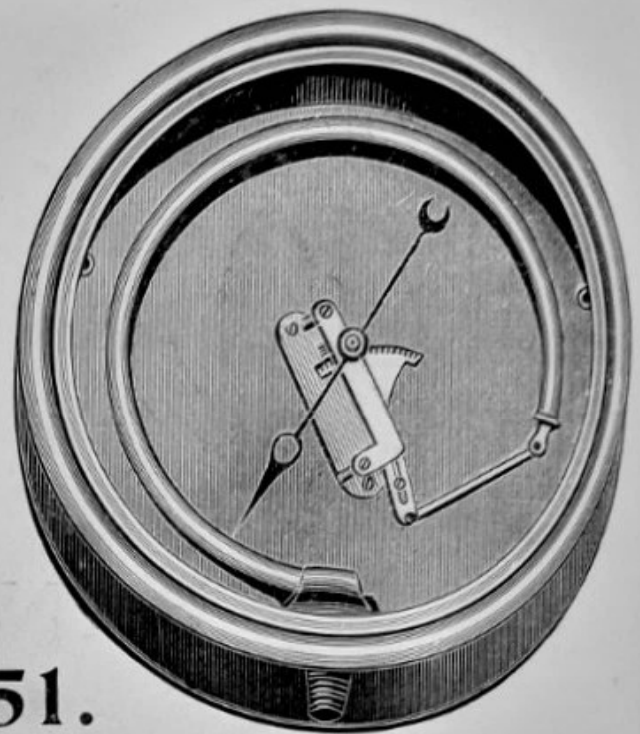

No. 51.

Springs of Solid Drawn Tube.

PRICES, INCLUDING COCK.

SIZE.	Iron Case Brass Ring.	Iron Case N. P. Ring.	Brass Case.	N. P. Case.	Brass Deep Case O. G. or Oct. Ring.	N. P. Deep Case O. G. or Oct. Ring.
12-inch Dial . .	\$50.00	\$51.50	\$75.00	\$79.00	\$80.00	\$84.00
10 "	32.00	33.00	40.00	43.00	44.00	47.00
8½ "	22.00	22.75	30.00	32.50	33.50	36.00
6¾ "	16.00	16.60	20.00	22.00	23.00	25.00
6 "	13.00	13.50	16.00	17.50		
5½ "	10.00	10.25	12.00	13.25		
5 "	8.00	8.20	11.00	12.00		
4½ "	8.00	8.20	10.00	11.00		
3½ "	7.00	7.18	9.00	9.75		
3 "	6.00	6.15	8.00	8.60		
2½ "	6.00	6.15	8.00	8.60		

Write for Discounts.

[N ordering always state size wanted, whether brass or iron case, and maximum pressure.

These gages made with non-corrosive movements.
Name on dial of

The Ashton Improved Double Spring Bourdon Steam and Pressure Gages.

(Lane's Improvement.)



No. 52.

Springs of Solid Drawn Seamless Tube.

PRICES, INCLUDING COCK.

SIZE.	Iron Case Japanned.	Iron Case N. P. Ring.	Brass Case.	N. P. Case.	Brass Deep Case O. G. or Oct. Ring.	N. P. Deep Case O. G. or Oct. Ring.
12-inch Dial . .	\$55.00	\$56.50	\$80.00	\$84.00	\$85.00	\$89.00
10 " . .	37.00	38.00	45.00	48.00	49.00	52.00
8½ " . .	25.00	25.75	34.00	36.50	37.50	40.00
6¾ " . .	18.00	18.60	22.00	24.00	25.00	27.00
6 " . .	15.00	15.50	18.00	19.50		
5½ " . .	12.00	12.25	14.00	15.25		
5 " . .	11.00	11.20	13.00	14.00		
4½ " . .	10.00	10.20	12.00	13.00		

Write for Discounts.

THIS gage is made with the Lane Improvement of the double spring, and is much preferable to the ordinary single-spring gage. Many of the objectionable features of the Bourdon Gage are obviated in this gage, there being no vibration of the hand, and with the short springs prevents freezing up in case of exposure.

Well adapted for locomotives, marine and portable boilers.

No extra cost for name on dials.

A siphon must invariably be used.

The Ashton Improved Vacuum Gages.

No. 53.

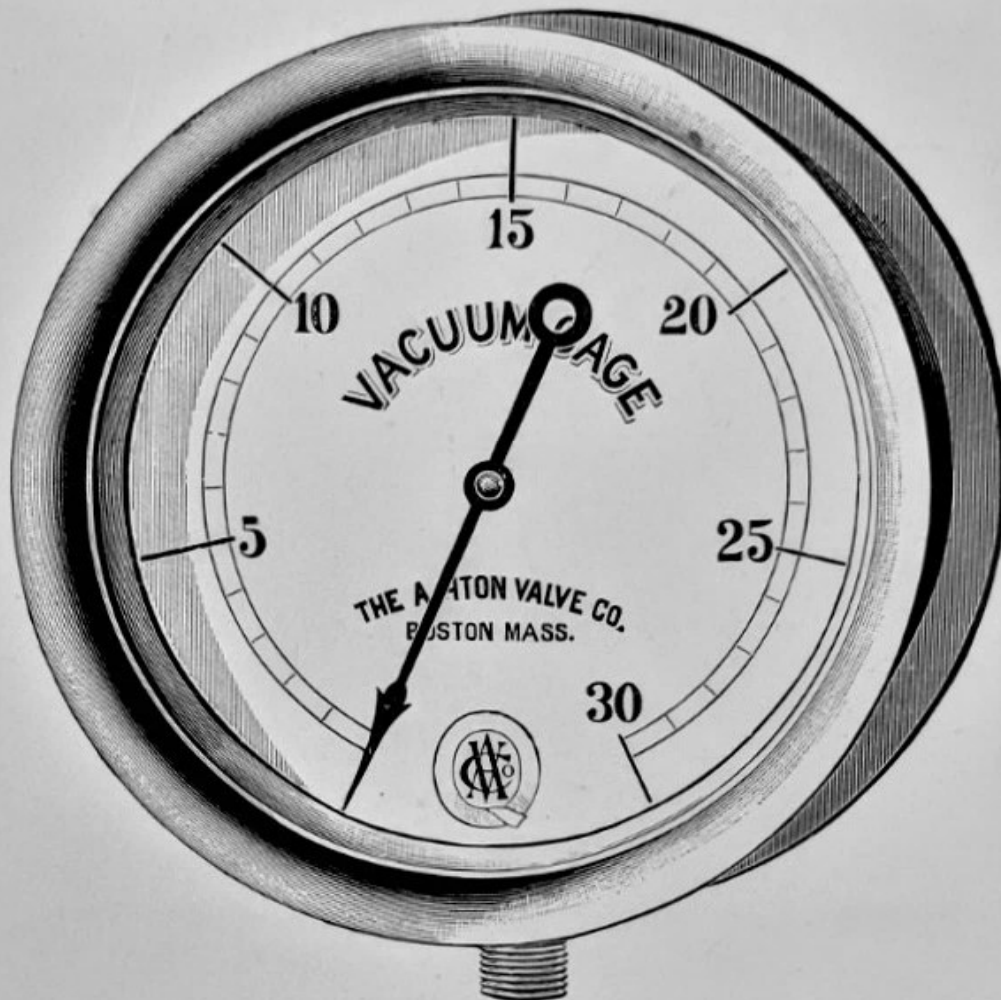

Springs of Solid Drawn Tube.

THE Ashton Improved Vacuum Gages are graduated to indicate vacuum in square inches of mercury

PRICES, INCLUDING COCK.

SIZE.	Iron Case Brass Ring.	Iron Case N. P. Ring.	Brass Case.	N. P. Case.	Brass Deep Case O. G. or Oct. Ring.	N. P. Deep Case O. G. or Oct. Ring.
12-inch Dial . .	\$50.00	\$51.50	\$75.00	\$79.00	\$80.00	\$84.00
10 " . .	32.00	33.00	40.00	43.00	44.00	47.00
8½ " . .	22.00	22.75	30.00	32.50	33.50	36.00
6¾ " . .	16.00	16.60	20.00	22.00	23.00	25.00
6 " . .	13.00	13.50	16.00	17.50		
5½ " . .	10.00	10.25	12.00	13.25		
5 " . .	8.00	8.20	11.00	12.00		
4½ " . .	8.00	8.20	10.00	11.00		
3½ " . .	7.00	7.18	9.00	9.75		
3 " . .	6.00	6.15	8.00	8.60		
2½ " . .	6.00	6.15	8.00	8.60		

The Ashton Compound Pressure and Vacuum Gages.



No. 54.

Springs of Solid Drawn Tube.

THESE Gages for indicating either pressure or vacuum are graduated for pressure in pounds per square inch, and for vacuum in inches of mercury column, fifteen pounds pressure being equal to about thirty inches of vacuum. If a pressure exceeding fifteen pounds is required it should be stated in ordering.

PRICES, INCLUDING COCK.

SIZE.	Iron Case Japanned.	Iron Case N. P. Ring.	Brass Case.	N. P. Case.	Brass Deep Case O. G. or Oct. Ring.	N. P. Deep Case O. G. or Oct. Ring.
12-inch Dial . . .	\$60.00	\$61.50	\$80.00	\$84.00	\$85.00	\$89.00
10 " . . .	40.00	41.00	50.00	53.00	54.00	57.00
8½ " . . .	30.00	30.75	40.00	42.50	43.50	46.00
6 " . . .	20.00	20.60	25.00	27.00	28.00	30.00
5½ " . . .	16.00	16.50	20.00	21.50		
4½ " . . .	14.00	14.25	16.00	17.25		
4 " . . .	12.00	12.20	14.00	15.00		
3½ " . . .	10.00	10.18	12.00	12.75		

Write for Discounts.

The Ashton Improved Hydraulic Gages.

No. 55.

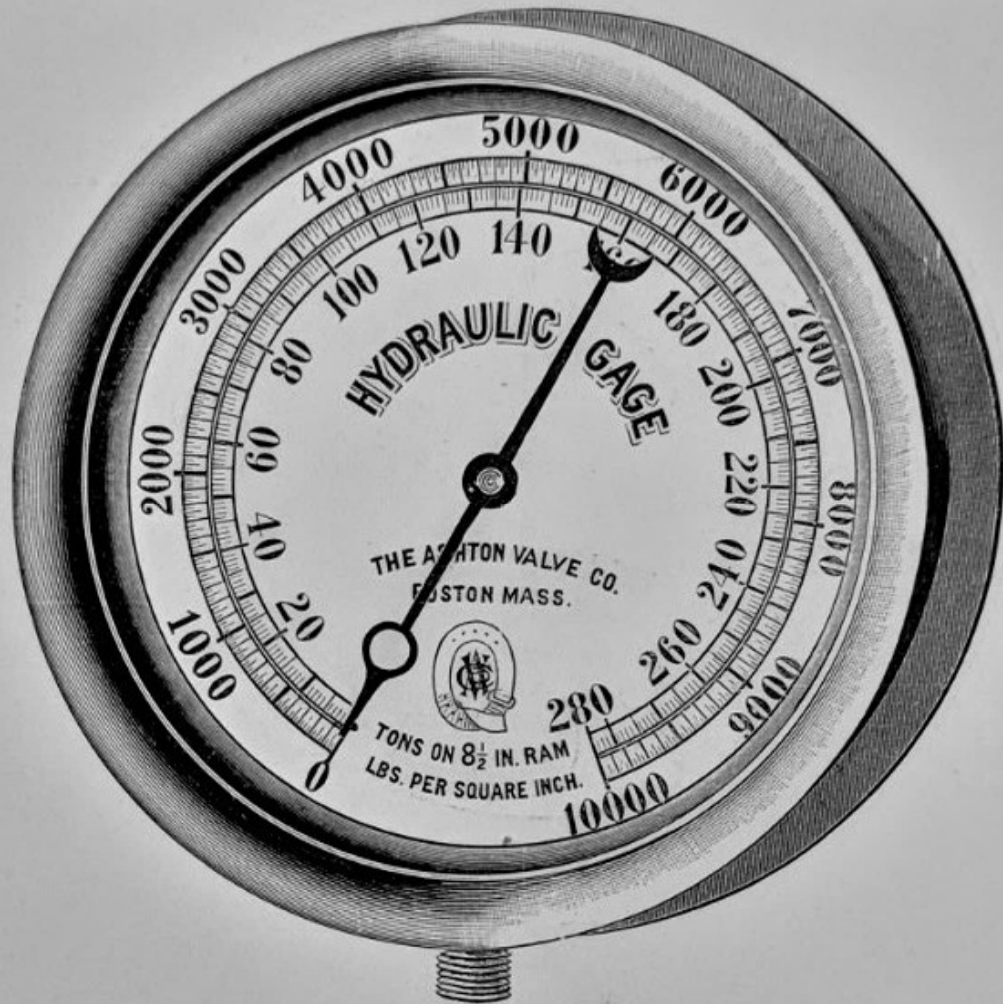

OUR Hydraulic Gages are made with special steel tubes for high pressures, and are accurately and carefully tested.

When ordering state maximum pressure required, and if dial is to show pressure in tons on ram, give exact diameter of ram.

PRICE LIST.

SIZE.	Iron Case Brass Ring.	Iron Case N. P. Ring.	Brass Case.	N. P. Case.
12-inch Dial . .	\$110.00	\$111.50	\$125.00	\$129.00
10 " . .	90.00	91.00	100.00	103.00
8 1/2 " . .	70.00	70.75	80.00	82.50
6 3/4 " . .	50.00	50.60	60.00	62.00
6 " . .	35.00	35.50	40.00	41.50

Write for Discounts.

Maximum hand, \$5.00 each.
Hydraulic Gages

The Ashton Combination Water Pressure Gages.



No. 56.

Springs of Solid Drawn Seamless Tube.

THESE gages, more especially adapted for water works, pumping stations, etc., are for indicating the pressure of water in pounds per square inch, and the corresponding height of water column.

PRICES, INCLUDING COCK.

SIZE.	Iron Case Japanned.	Iron Case N. P. Ring.	Brass Case.	N. P. Case.	Brass Deep Case O. G. or Oct. Ring.	N. P. Deep Case O. G. or Oct. Ring.
12-inch Dial . .	\$60.00	\$61.50	\$80.00	\$84.00	\$85.00	\$89.00
10 " . .	40.00	41.00	50.00	53.00	54.00	57.00
8½ " . .	30.00	30.75	40.00	42.50	43.50	46.00
6 " . .	20.00	20.60	25.00	27.00	28.00	30.00
5½ " . .	16.00	16.50	20.00	21.50		
	14.00	14.25	16.00	17.25		

Write for Discounts.

To raise a column of mercury 2.04 inches, or to raise a column of water 27.67 inches . . .

The Ashton Improved Ammonia Gages.

No. 57.



OUR Ammonia Gages are made with all the interior parts of iron excepting the springs, which are of steel, to withstand ammonia, or any other gas or acid which attacks the ordinary Bourdon spring. When desired these gages are made to indicate both pressure and vacuum on the same dial, but ordinarily only show pressure.

PRICE LIST.

SIZE.	Iron Case and Ring.	Iron Case N. P. Ring.
8 or 8½-inch Dial		
6¾ " "	\$45.00	\$45.75
6 " "	40.00	40.60
	35.00	35.50

The Ashton Pyrometer Steam Gages.



No. 58.

Springs of Solid Drawn Tube.

FOR indicating pressure of steam in pounds per square inch, and corresponding degrees of heat. The inner circle indicates pounds pressure per square inch, and the outer circle the corresponding degrees of heat.

PRICES, INCLUDING COCK.

SIZE.	Iron Case Japanned.	Iron Case N. P. Ring.	Brass Case.	N. P. Case.	Brass Deep Case O. G. or Oct. Ring.	N. P. Deep Case O. G. or Oct. Ring.
12-inch Dial . .	\$60.00	\$61.50	\$80.00	\$84.00	\$85.00	\$89.00
10 " . .	40.00	41.00	50.00	53.00	54.00	57.00
8½ " . .	30.00	30.75	40.00	42.50	43.50	46.00
6¾ " . .	20.00	20.60	25.00	27.00	28.00	30.00
6 " . .	16.00	16.50	20.00	21.50		
5½ " . .	14.00	14.25	16.00	17.25		

Write for Discounts.

In ordering state maximum pressure or temperature required.

A Siphon is indispensable with these gages.

The Ashton Standard Test Gages.

No. 59.



Springs Made of Solid Drawn Seamless Tube.

OUR Standard Test Gages are made with the greatest of care, and with the best material and workmanship possible in the present state of the art.

Each gage is most carefully adjusted, tested, and graduated by our mercury column, and scaled in one-pound marks.

For accuracy, sensitiveness, and workmanship there are no better gages made.

PRICES, INCLUDING COCK.

Size.	Brass Case.	N. P. Case.
10-inch Dial		
8½ "	\$50.00	\$53.00
6¾ "	40.00	42.50
6 "	30.00	32.00
5½ "	25.00	26.50
4½ "	20.00	21.25

The Ashton Improved Altitude Gages.

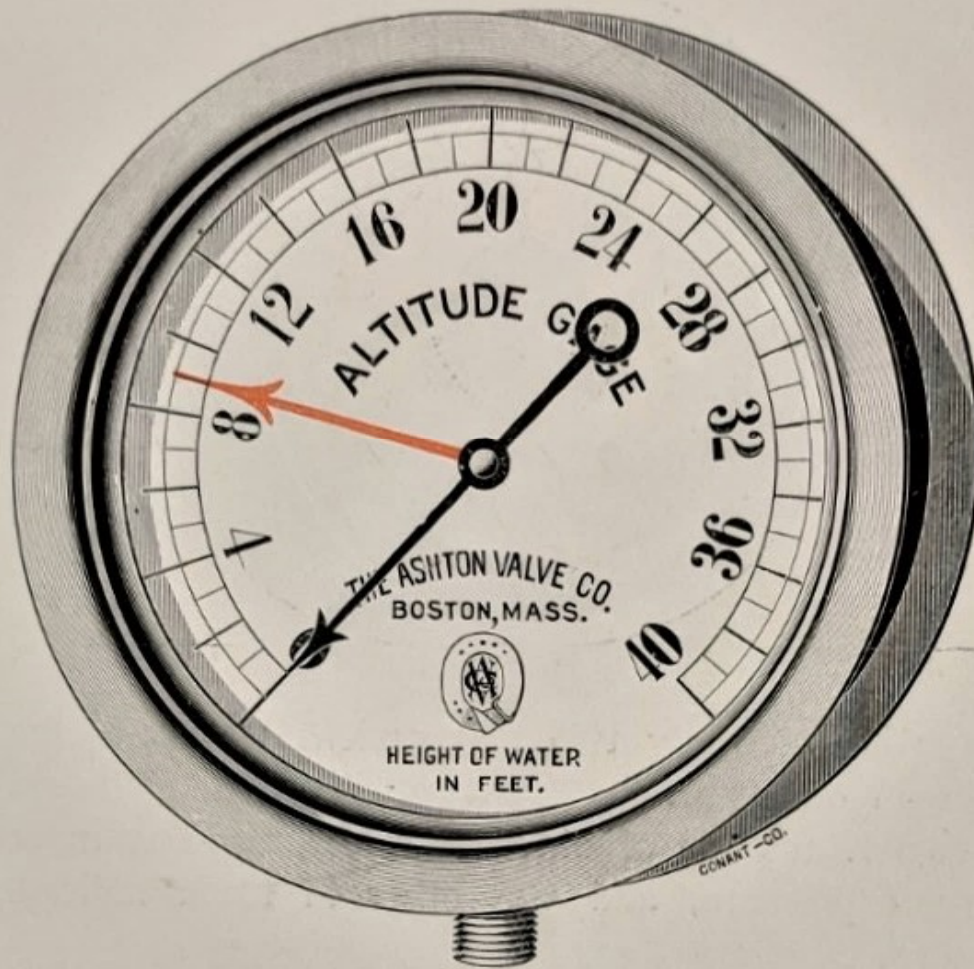

No. 60.

THIS gage is especially adapted for use on hot-water heaters, to indicate the height of water in the tank or reservoir. The black hand, being actuated by the pressure of the column of water, shows the variations in the height of water in the tank. The red hand, which is independent from the gage tube, is to be set by the user, when the gage is put up, at exactly the number of feet that the height of the water should be maintained in the tank.

PRICES, INCLUDING COCK.

SIZE.	Iron Case, Japanned.	Iron Case, N. P. Ring.	Brass Case.	N. P. Case.	Brass Deep Case, O. G. or Oct. Ring.	N. P. Deep Case, O. G. or Oct. Ring.
12 inch Dial,	\$60.00	\$61.50	\$80.00	\$84.00	\$85.00	\$89.00
10 "	40.00	41.00	50.00	53.00	54.00	57.00
8½ "	30.00	30.75	40.00	42.50	43.50	46.00
6 "	20.00	20.60	25.00	27.00	28.00	30.00
5½ "	16.00	16.50	20.00	21.50	23.00	24.50
4½ or 5 "	14.00	14.25	16.00	17.25	18.50	19.75
	12.00	12.20	14.00	15.00	16.00	17.00

The Ashton Duplex Air Brake Gages.

No. 62.

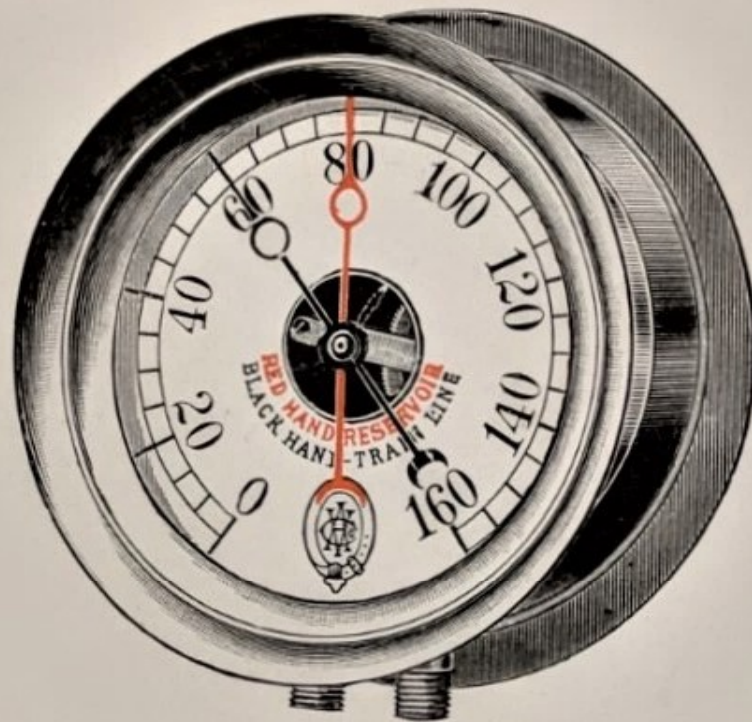

THIS gage is practically two independent Double-Spring Bourdon Gages in one case.

The two hands are of different colors, the one in red indicating Reservoir pressure, and the other in black indicating Train-Line pressure.

The movements are non-corrosive, having German-silver pinions and arbors, and the springs are of the best quality solid drawn seamless tube.

This gage made only in 5-inch size, with deep brass case. Price \$20.

Write for Discounts.

Diaphragm Gages.

No. 61.

We furnish a superior quality of diaphragm gage for use in connection with ammonia, acids, soda, or gases, which would materially affect the spring of the ordinary gage.

This style gage is designed more especially for use where the Bourdon Spring Gage is not suitable.

The Ashton Locomotive and Marine Clocks.

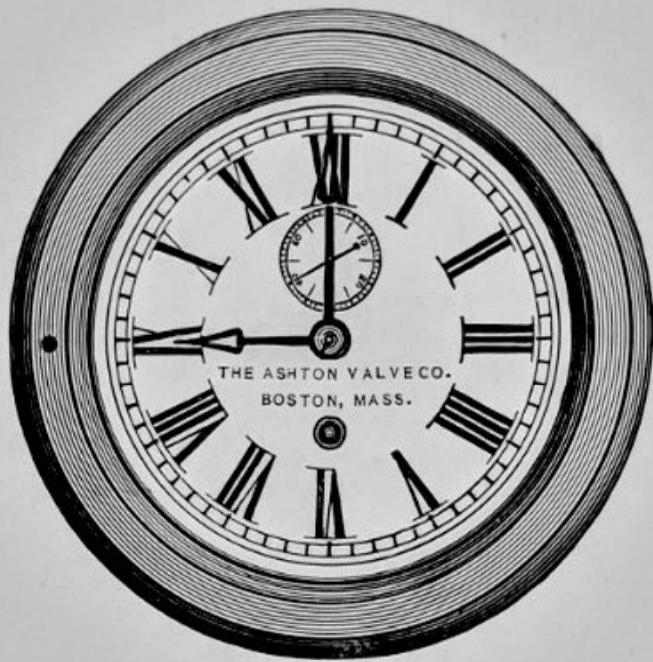

No. 63.

THE Howard and Boston movements are full jeweled with chronometer balance, and have patented regulators.

The cases are made with hinged rings and snap latch, or lock and key when desired.

PRICE LIST.

SIZE.	Movement.	Time.	Brass Case.	N. P. Case O. G. or Oct. Ring.
12-inch Dial . . .	Howard.	8 day.	\$110.00	\$114.00
10 " . . .	"	"	90.00	93.00
8½ " . . .	"	"	80.00	82.50
6¾ " . . .	"	"	70.00	72.00
12 " . . .	Seth Thomas.	"	90.00	94.00
10 " . . .	"	"	65.00	68.00
8½ " . . .	"	"	55.00	57.50
6¾ " . . .	"	"	45.00	47.00
12 " . . .	Boston.	"	90.00	94.00
10 " . . .	(formerly Harvard)	"	65.00	68.00
8½ " . . .	"	"	55.00	57.50
6¾ " . . .	"	"	45.00	47.00
6 " . . .	"	"	40.00	41.50
5½ " . . .	"	"	38.00	39.25
5 " . . .	"	"	35.00	36.00

Gage Frame for Set of Four Instruments.

No. 1 PATTERN.



Gage Frame for Set of Five Instruments.

No. 2 PATTERN.



Price List of Gage Frames.

				No. 1 PATTERN.	No. 2 PATTERN.
For two	6-inch	dial instruments	. .	\$8.00	
For three	6-inch	"	. .	13.00	
For four	6-inch	"	. .	16.00	\$22.00
For five	6-inch	"	. .	20.00	30.00
For seven	6-inch	"	. .		40.00
For two	6 ³ / ₄ -inch	"	. .	13.00	
For three	6 ³ / ₄ -inch	"	. .	15.00	
For four	6 ³ / ₄ -inch	"	. .	20.00	27.00
For five	6 ³ / ₄ -inch	"	. .	25.00	35.00
For seven	6 ³ / ₄ -inch	"	. .		45.00
For two	8 ¹ / ₂ -inch	"	. .	15.00	
For three	8 ¹ / ₂ -inch	"	. .	20.00	
For four	8 ¹ / ₂ -inch	"	. .	25.00	33.00
For five	8 ¹ / ₂ -inch	"	. .	30.00	42.00
For seven	8 ¹ / ₂ -inch	"	. .		55.00
For two	10-inch	"	. .	18.00	
For three	10-inch	"	. .	22.00	
For four	10-inch	"	. .	30.00	40.00
For five	10-inch	"	. .	35.00	52.00
For seven	10-inch	"	. .		70.00
For two	12-inch	"	. .	20.00	
For three	12-inch	"	. .	25.00	48.00
For four	12-inch	"	. .	32.00	60.00
For five	12-inch	"	. .	38.00	80.00
For seven	12-inch	"	. .		

When name plates are wanted with gage frames they will be

Siphons and Cocks.



FIG. 1.

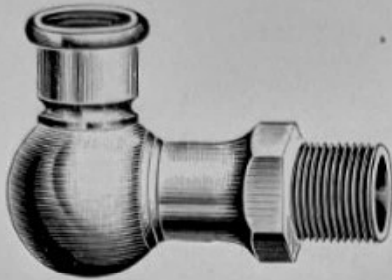

FIG. 2.

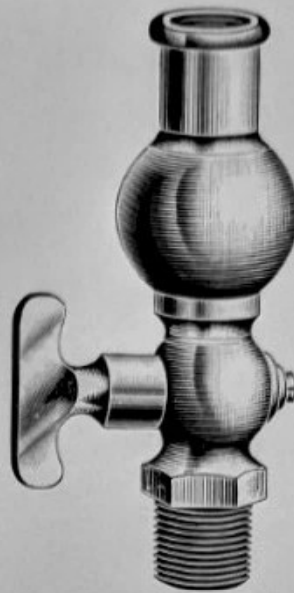

FIG. 3.

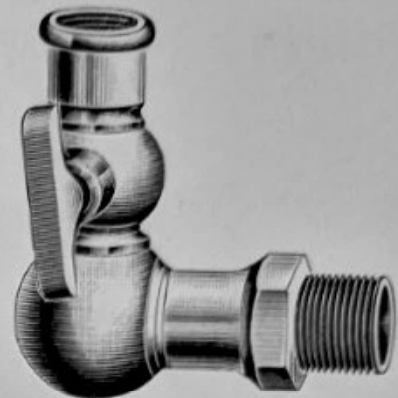
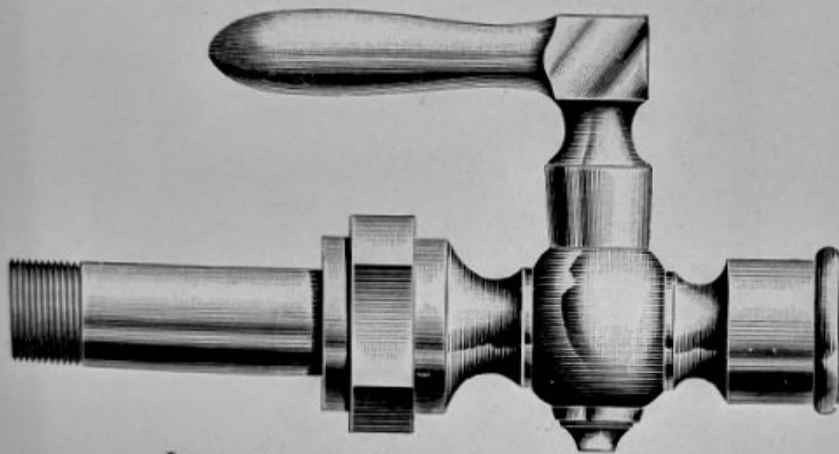
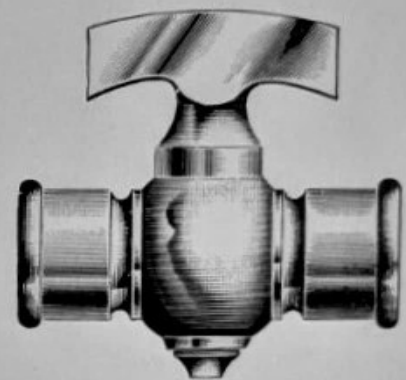

FIG. 4.



Lever Handle Union Steam Gage Cock.



T Handle Steam Gage Cock.

PRICE LIST.

SIPHONS AND COCKS.	Brass.	N. P.
Common Iron Pipe Siphon, each . . .	\$.25	
Common Brass Pipe Siphon, each . . .	1.00	\$1.50
Common T Handle Brass Cock50	.75
Heavy T Handle Brass Cock	1.00	1.50
Small Union, Brass Cock	1.50	2.00
Large Union, Brass Cock	2.00	2.50
Straight Siphon, without cock, Fig. 1 . . .	1.00	1.50
Elbow Siphon, without cock, Fig. 2 . . .	1.25	1.75
Straight Siphon, with cock, Fig. 3 . . .	1.50	2.00
Elbow Siphon, with cock, Fig. 4	1.50	2.00

Write for Discounts.

Siphons must be used with steam gages

No. 1 Standard Lever Test Pump.

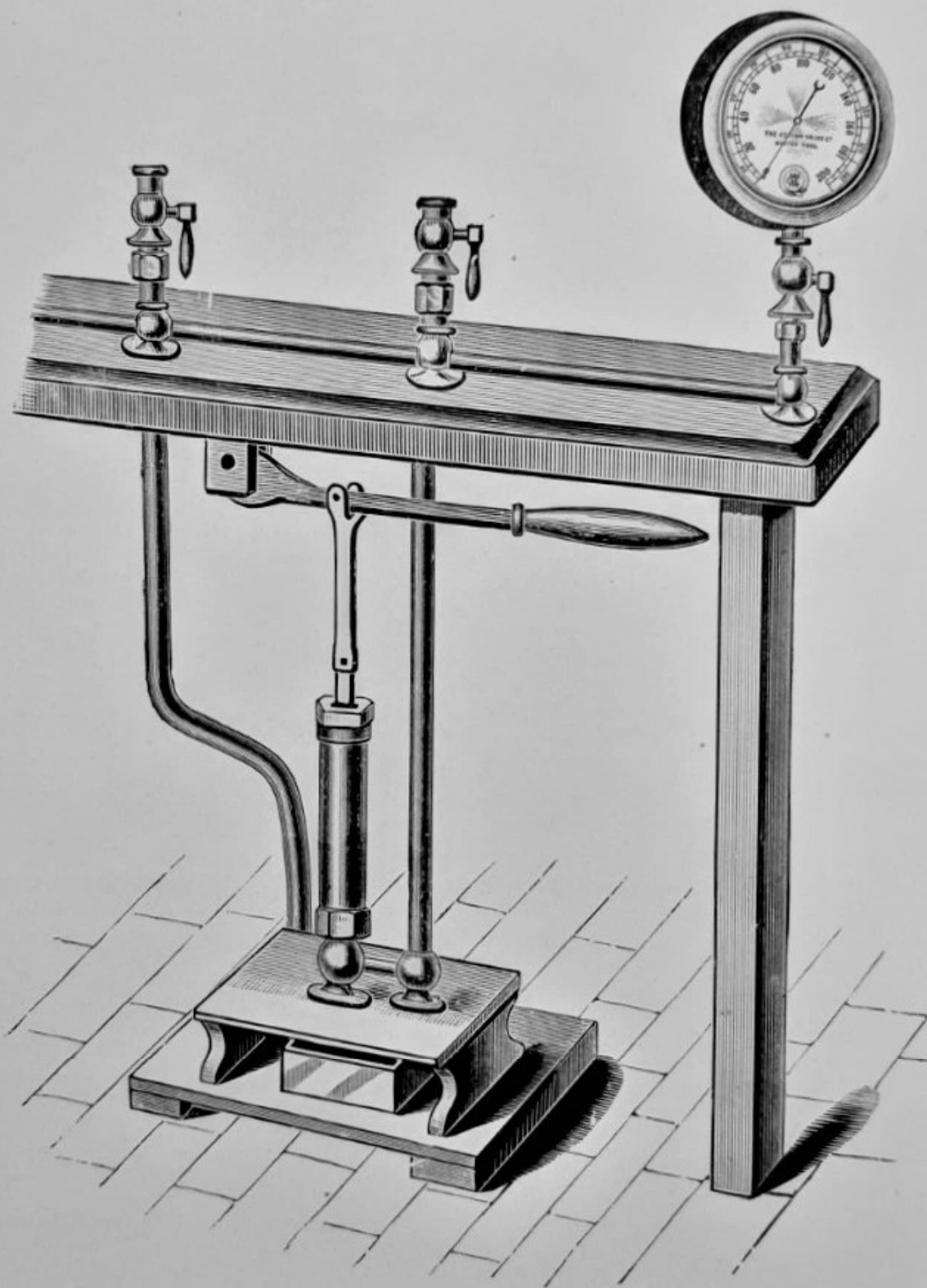

THIS pump is carefully made and so arranged that two gages can be tested at the same time.

It is especially adapted for railroads and companies using large numbers of gages.

Price, without gage, \$50.00.

For price of test gages see page 16.

No. 2 Level Pump and Test Gage.

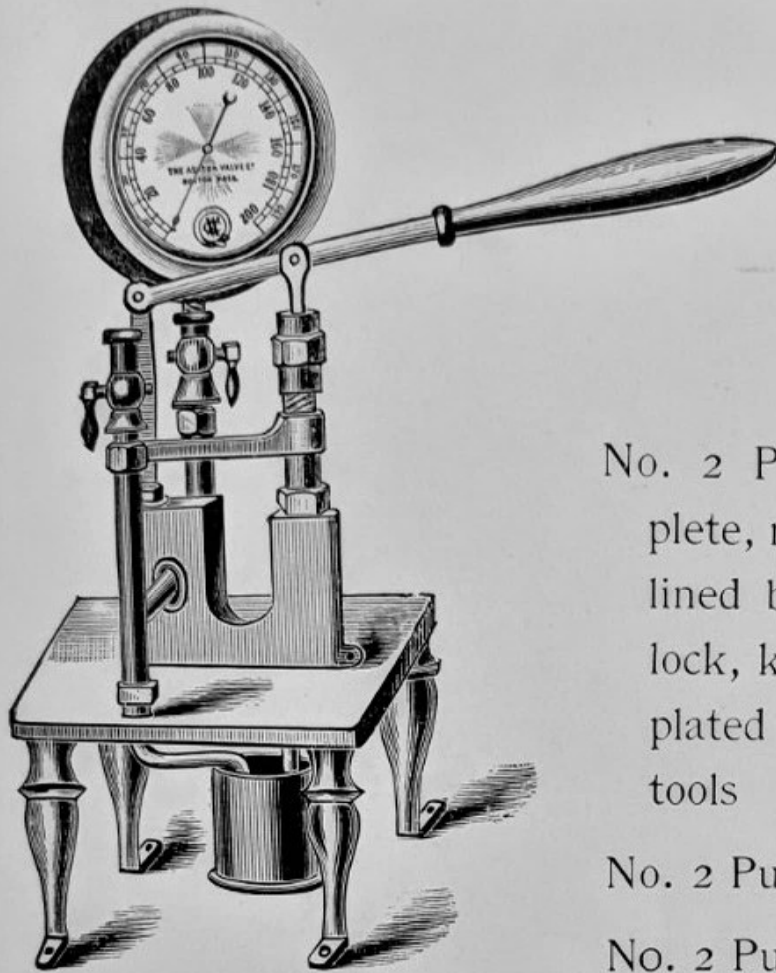

OUR No. 2 Pump is compact, neat, and durable.

It occupies only a space of nine inches square.

PRICES.

- No. 2 Pump and Gage complete, nickel plated, in velvet-lined black walnut box, with lock, key and handles, nickel-plated trimmings, and small tools \$75.00
- No. 2 Pump only, nickel-plated, 50.00
- No. 2 Pump only, plain brass, 40.00

No. 3 Screw Pump and Test Gage.

OUR No. 3 Screw Pump is especially adapted for Boiler Inspectors.

PRICES.

- No. 3 Screw Pump and 3½-inch Test Gage, all nickel plated, \$30.00
- No. 3 Screw Pump and 3½-inch Test Gage, plain brass . . . 28.00
- No. 3 Screw Pump only, nickel plated 14.00
- No. 3 Screw Pump only, brass, 12.00

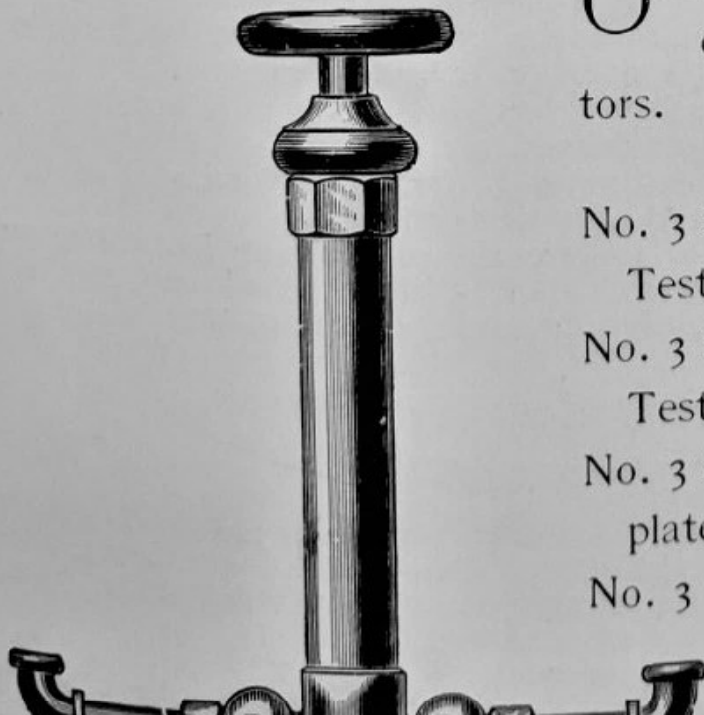

For price of test gages

Edson Pressure Recording Gage.

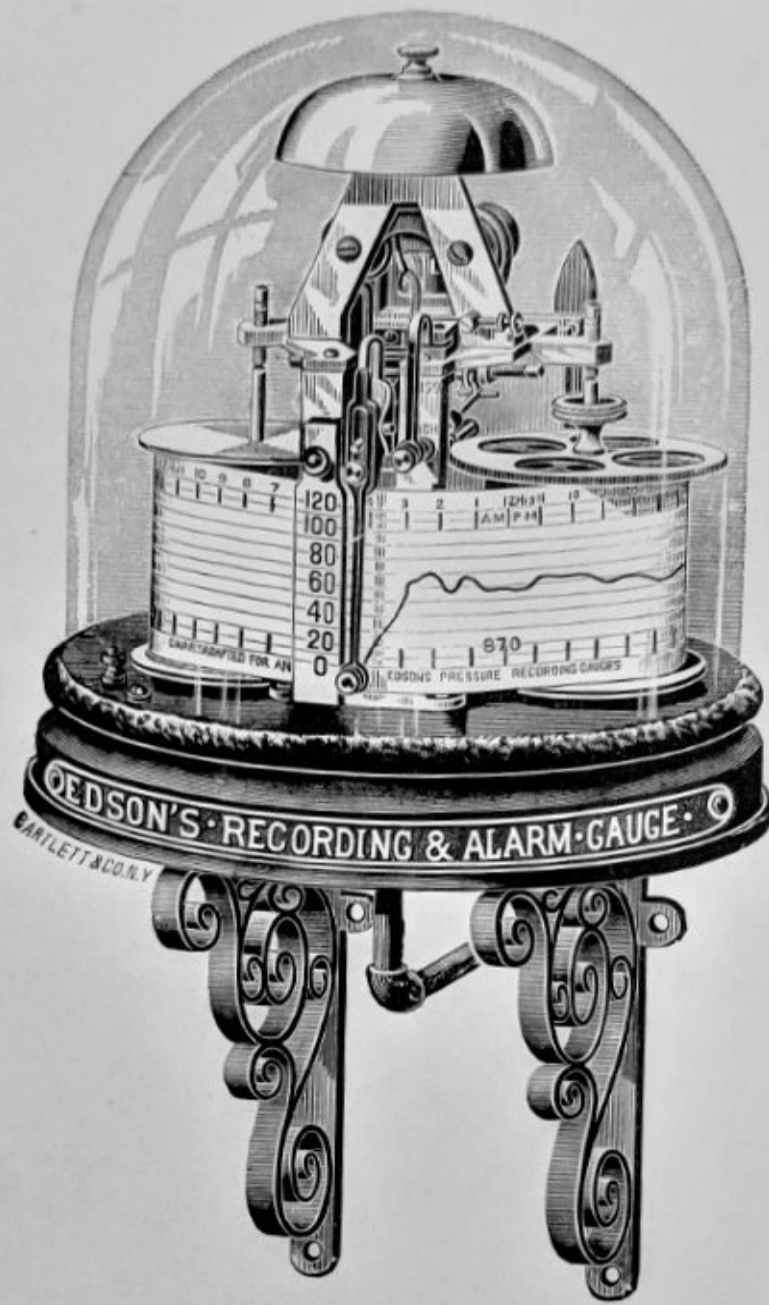

THESE Gages always accurately record the pressure carried, and register on the chart the exact time and duration of every variation. The fact that a record is kept tends to insure better service and prevents accidents.

The presence of one of these gages causes careful firing and steady steam, and increases the efficiency of any engine or boiler. Any omission of duty or want of economy in using fuel is always detected.

The above cut represents the No. 1 Style Edson Pressure Recording and Alarm Gage for steam, air, gas, oil, or water. Without hand and dial, but having adjustable circuit closer for high pressure, operating an electric bell located on the instrument.

Price \$85.00.

Write for Discount.

Price includes one year's supply of charts, numbered consecutively for each day in the year, and ruled to the special scale of the instrument; also, one special album for filing away the charts daily as recorded upon; also, one lot of shelf and brackets, boxes, and other accessories.

Peerless Pressure Recording Gage.

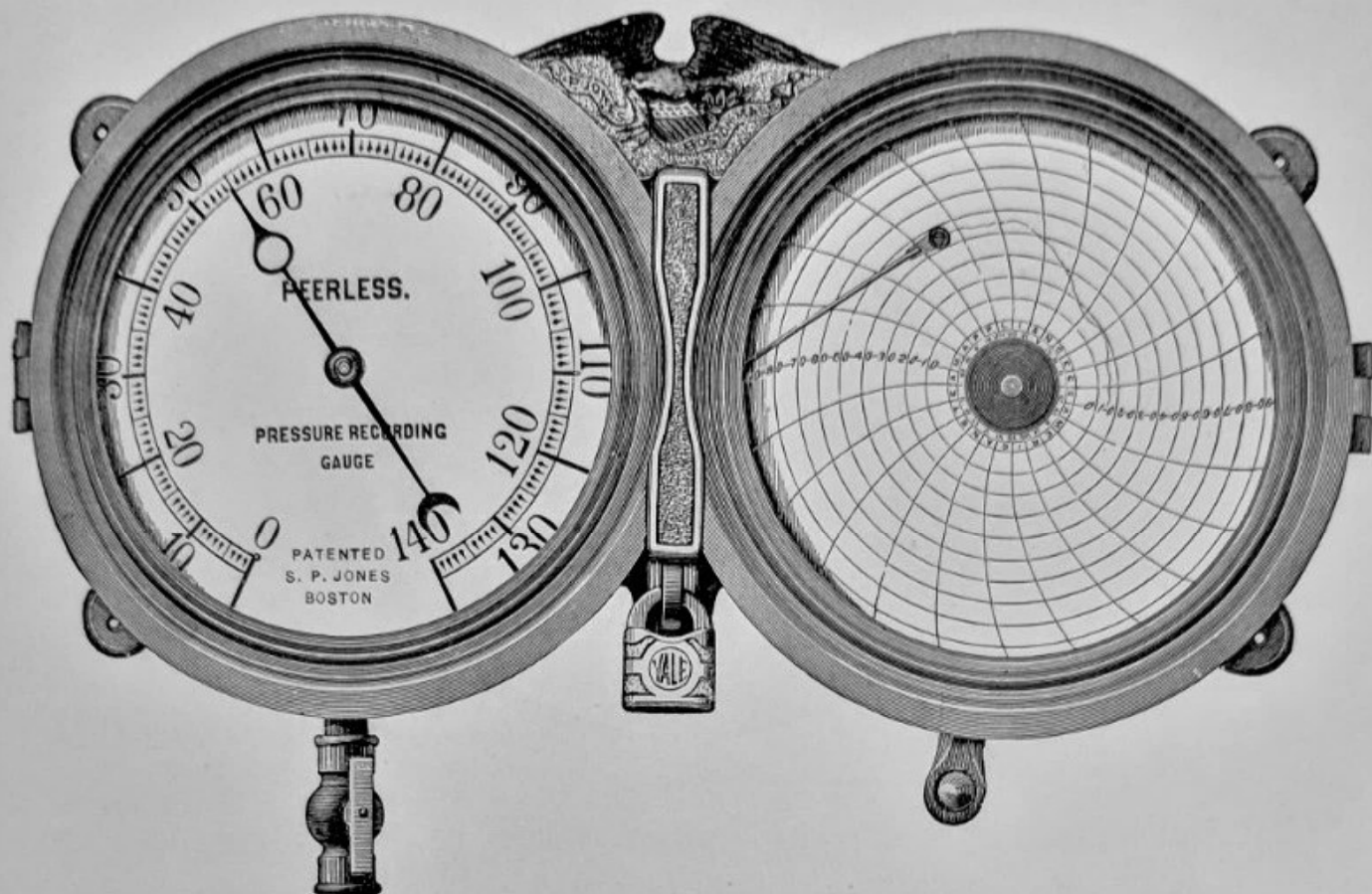

THE Peerless Recording Gage makes a complete and accurate record or chart of the pressure and all its variations, with the time and duration of all changes. These charts are designed to be dated and filed for reference.

It is a valuable and necessary fixture in connection with Steam Boiler Plants and Heating Apparatus of all kinds, and where used always insures economy and greater efficiency. Negligence and carelessness become Recorded Facts by the use of these gages.

The Peerless Gage, owing to the size of the chart, makes a large record, and shows at a glance the entire record for twenty-four hours. It also has lock-up attachment.

Every instrument is mounted on a black walnut board, and is provided with a Yale lock, two keys, 350 dials, leads, and union cock, all complete and included with gage.

Price \$100.00.

Water Columns.

FOR WATER GAGES AND GAGE COCKS.

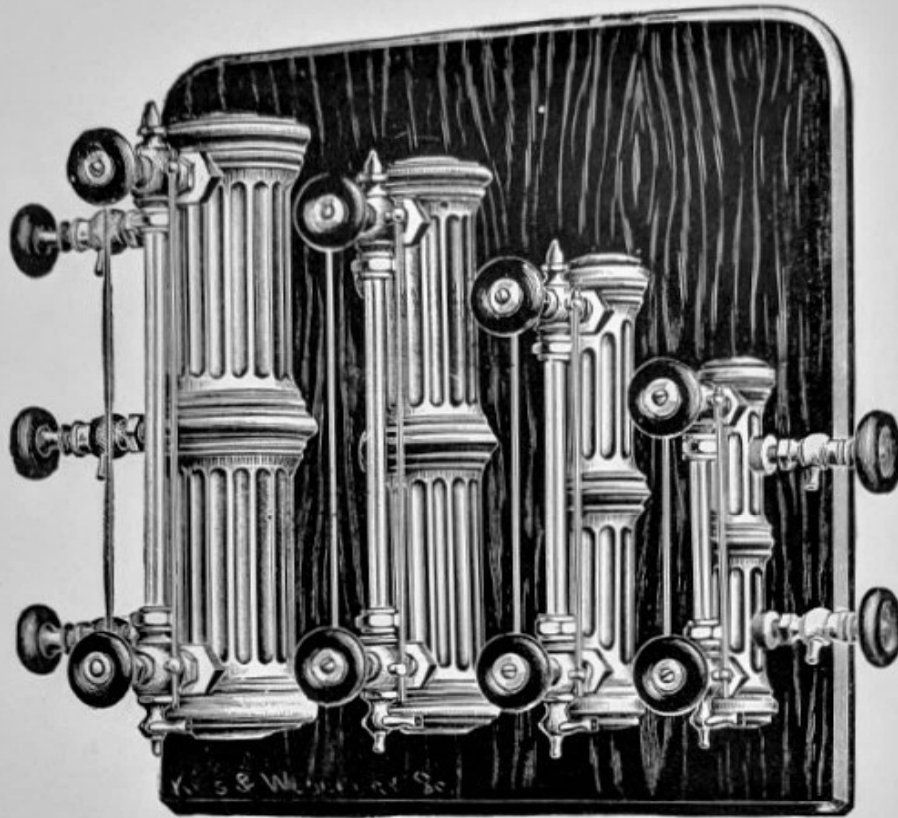

BRONZED IRON WATER COLUMNS.

THESE columns are tapped for $\frac{3}{8}$ inch, $\frac{1}{2}$ inch, or $\frac{3}{4}$ inch fittings, according to size, and have boiler connections 1 inch or $1\frac{1}{4}$ inch as desired.

A siphon must always be used between gage and water column.

Prices for the columns only; they do not include water gages or gage cocks, steam gage or siphon.

STYLE.	No. 1.	No. 2.	No. 3.	No. 4.
Total length in inches	11 $\frac{1}{2}$	15 $\frac{1}{2}$	18 $\frac{3}{4}$	21
Length glass "	7	10	13	15
Price	\$2.50	\$3.00	\$4.00	\$5.00

Write for Discounts.

Common Water Gages.

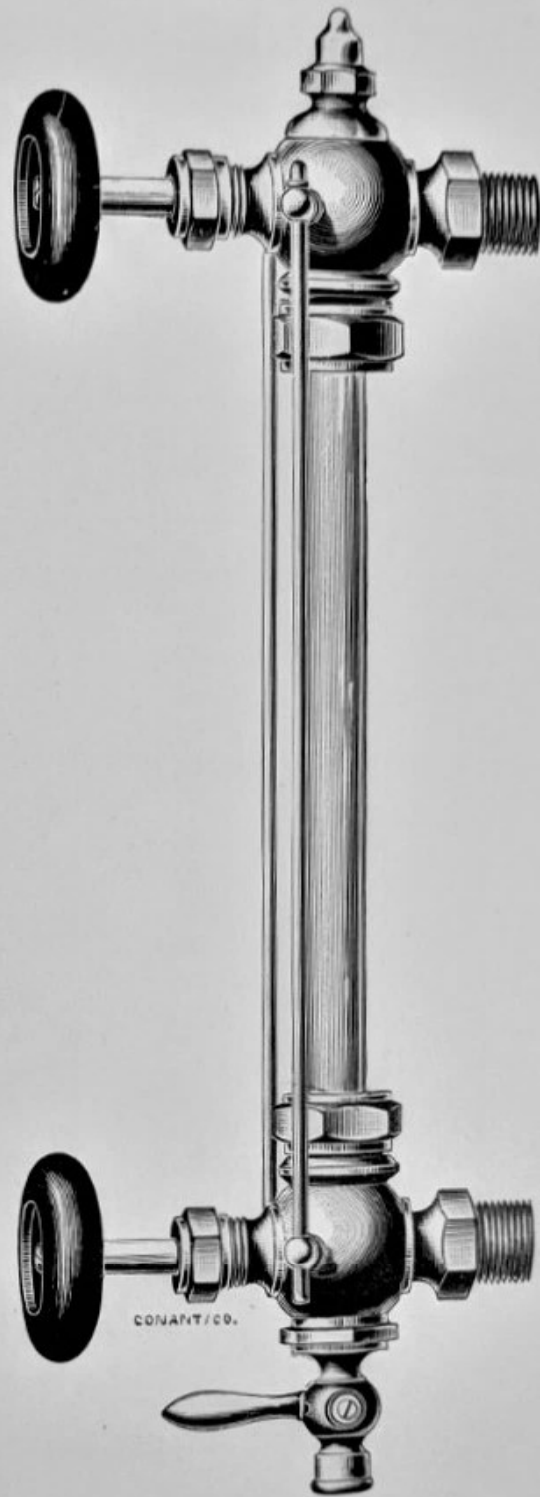
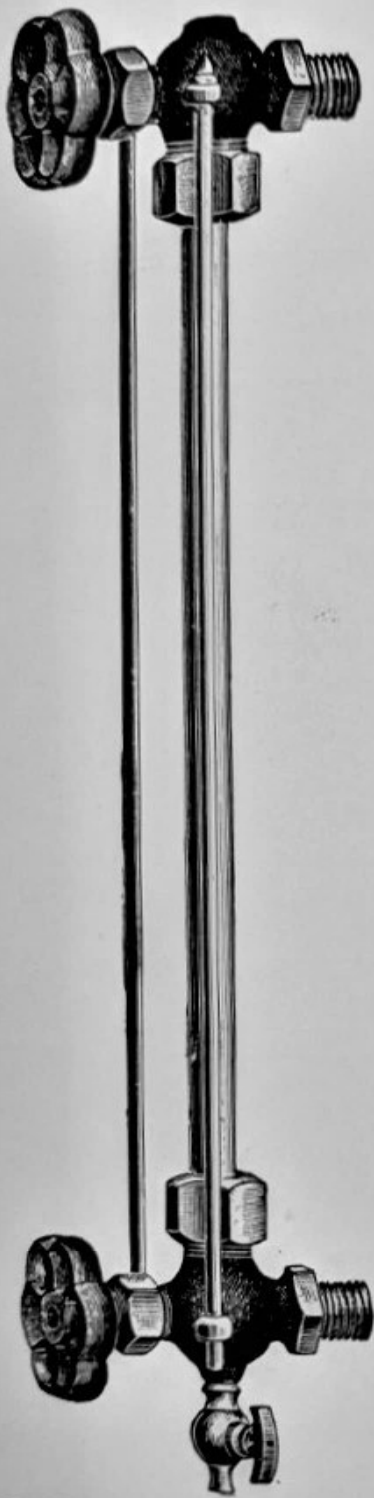

No.	Threaded.	Size Glass.	No. Rods.	Description.	Handles.	Price.
1	$\frac{3}{8}$	$\frac{1}{2}$ X 10	2	Rough Body, Bronzed	Iron	\$3.00
2	$\frac{3}{8}$	$\frac{1}{2}$ X 10	2	Finished all over	Wood	4.00
3	$\frac{1}{2}$	$\frac{5}{8}$ X 12	2	Rough Body, Bronzed	Iron	3.00
4	$\frac{1}{2}$	$\frac{5}{8}$ X 12	2	Finished all over	Wood	4.25
5	$\frac{1}{2}$	$\frac{5}{8}$ X 12	4	Finished, Square Body	Wood	6.00
6	$\frac{3}{4}$	$\frac{3}{4}$ X 16	2	Rough Body, Bronzed	Iron	7.50
7	$\frac{3}{4}$	$\frac{3}{4}$ X 16	2	Finished Body, Glass through Top	Wood	9.00

Moncrieff's Genuine Scotch Glass Tubes.

REVISED PRICE LIST.

PRICE PER DOZEN.

LENGTH.	EXTERNAL DIAMETER.			
Inches.	1/2 and 5/8	3/4	7/8	1 in.
10	\$3.00	\$3.60	\$5.04	\$6.12
11	3.24	3.96	5.64	6.72
12	3.60	4.32	6.12	7.32
13	3.84	4.80	6.60	7.92
14	4.20	5.16	7.08	8.52
15	4.44	5.52	7.56	9.12
16	4.80	5.88	8.16	9.72
17	5.04	6.24	8.64	10.32
18	5.40	6.60	9.12	10.92
19	5.64	7.08	9.60	11.52
20	6.00	7.44	10.20	12.12
22	6.60	8.16	11.16	13.44
24	7.20	8.88	12.12	14.64
30	9.00	11.16	15.24	18.24
36	10.80	13.44	18.24	21.96
48	14.52	18.00	24.36	29.16
60	18.12	22.56	30.48	36.48
72	21.84	27.12	36.48	43.80

60 × 1 1/4 inches, \$60.00.

Sizes longer than 24 inches, Special Discount.

THESE Gage Glasses are imported direct from Perth, Scotland. The size is labeled on end of each package, making them more desirable for stock. We warrant them genuine and equal to any in the market.

Lengths not regular charged the price of next longer tubes of same diameter.

The Glasses will stand very high pressure, bear great variation of temperature, and they are fairly

Compression Gage Cocks.



PRICES.

Size	$\frac{3}{8}$	$\frac{1}{2}$	$\frac{3}{4}$
With Patent Wood Wheel . .	\$1.10	\$1.20	\$1.35
With Patent Wood Wheel and Stuffing Box	1.30	1.40	1.55

Gage Hand Puller.

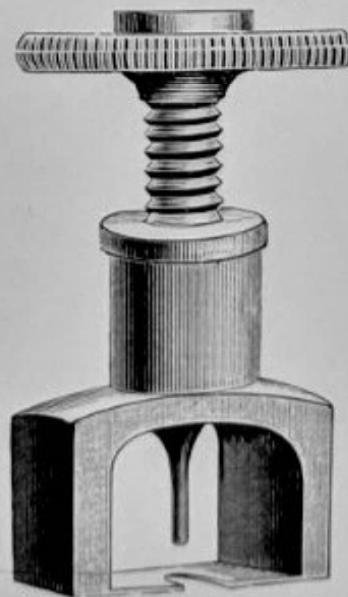

OUR Gage Hand Puller is a simple and handy little tool for

The Thompson Improved Indicator.

Patented August 31, 1875, July 12, 1881, and June 26, 1883.

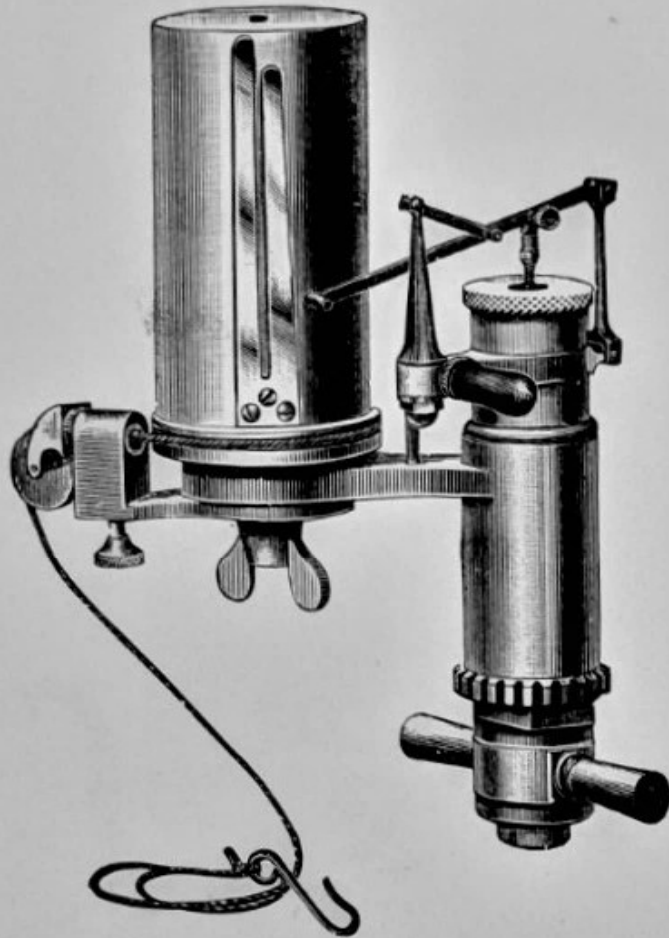

Fig. 1. — OUTSIDE.

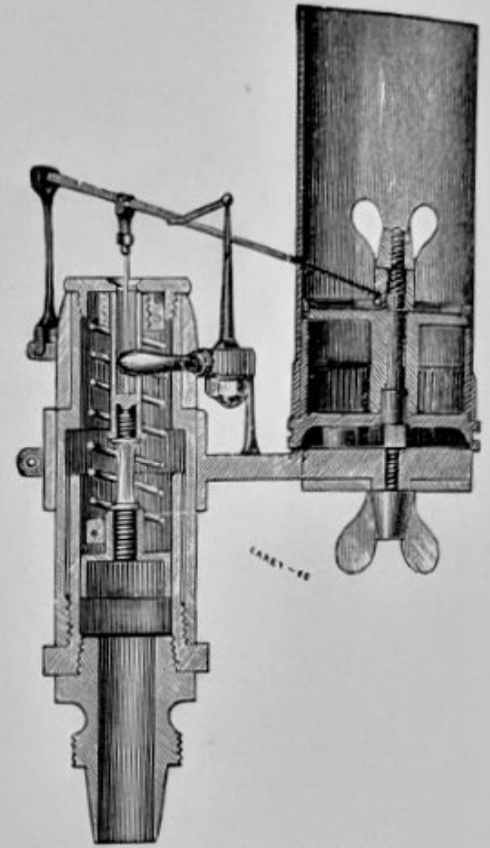

Fig. 2. — INSIDE.

PRICES.

Thompson Improved Indicator and Extra Fixtures.

Thompson Indicator complete, with one spring, *in the instrument*, one scale, two cocks, all necessary wrenches to use on the instrument, one screw-driver, one bottle watch-oil, and Pray's "Twenty Years with the Indicator," all enclosed in a neat mahogany box . . . \$85.00

Thompson Indicator, with the above fixtures, and nickel-plated . . . 88.00

Extra Piston, 1/4-in. area . . .	\$10.00	Parallel Rule	7.00
" Springs, each	5.00	Reducing Pulley	25.00
" Boxwood Scales50	Clamps	3.00
" Steel Scales	1.50	Metallic Cards per 1,000	15.00
" Cocks	2.75	Common Cards	7.50
" Elbows	2.50	Detent Motion	3.00
Three-way Cock	6.00	Pantograph	10.00
Single Carrying Pulley,60	Planimeter	15.00
Double "	1.20		

Steel Indicator.

THOMPSON Improved Indicators, all steel, to withstand the action of the

Aluminum Reducing Wheel for Indicator.

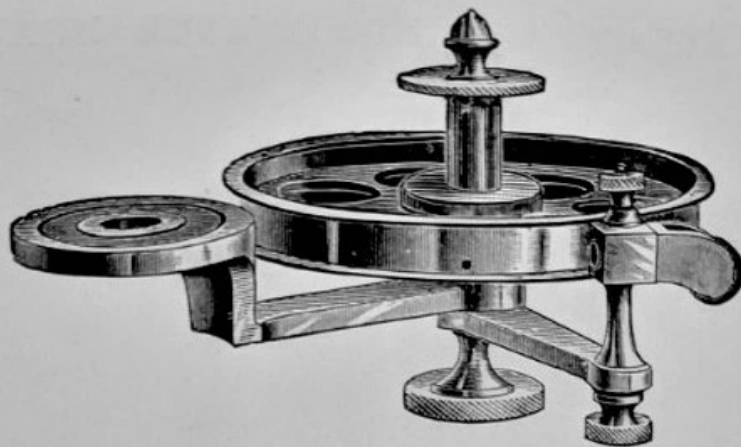

APPLICATION.

A DEVICE for reducing the motion of an engine cross-head to that required for the paper drum of an Indicator.
For either Upright or Horizontal Engines of not over 6-ft. stroke.

ADVANTAGE.

Ease and Quickness of Application.

With cylinder arranged for the applying of Indicator a card can be taken at any time without stopping engine inside of ten minutes.

The elaborate preparation and time necessary to adjusting Pantograph or Pendulum entirely done away with.

Price \$25.00.

Amsler's Polar Planimeter.

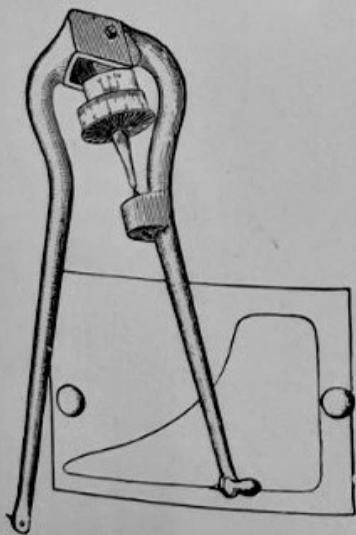

FOR measuring the area of Indicator Diagrams. By use of this instrument the whole work of measuring a diagram can be done in a very short time.

Price \$15.00.

Indicator Springs.

TO adapt the Indicator to all pressures, we furnish Springs to any desired scale. The following are the most generally used: 8, 10, 12, 16, 20, 24, 30, 32, 40, 48, 50, 56, 60, 65, 70, 75, 80, 85, 90, 100 pounds, a 40-

Thermometers

FOR STEAM AND HOT WATER HEATING.

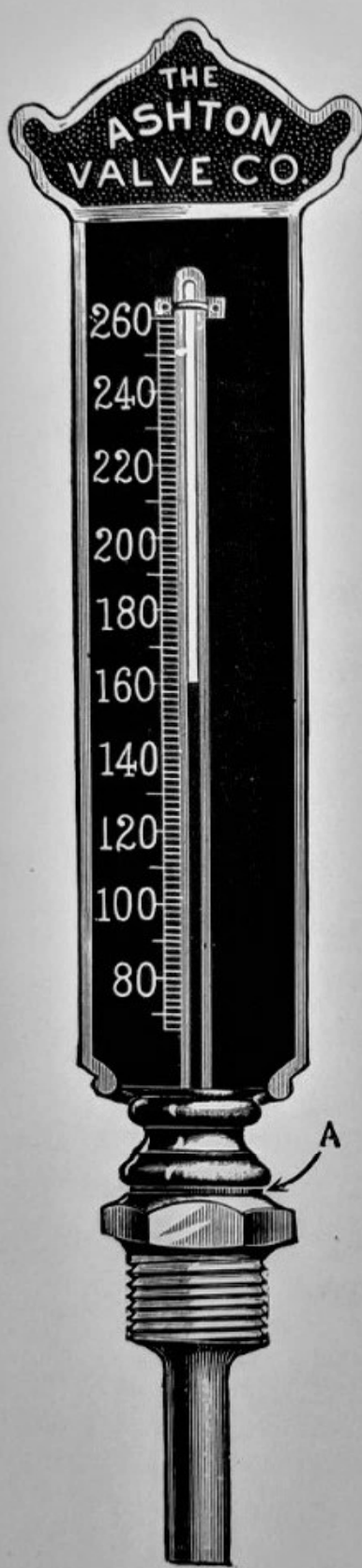

Fig. 1.

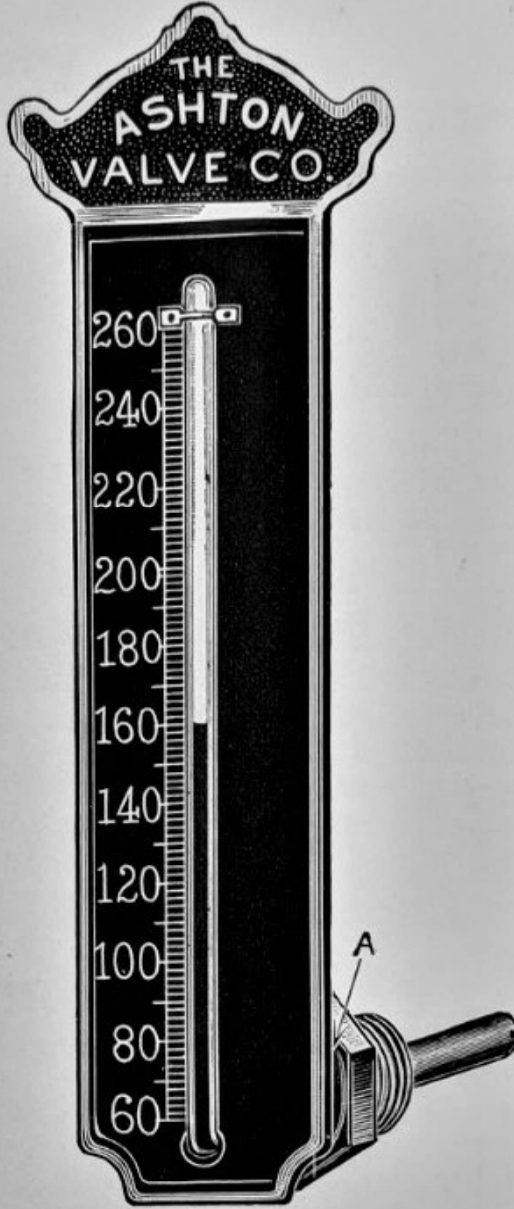

Fig. 3.

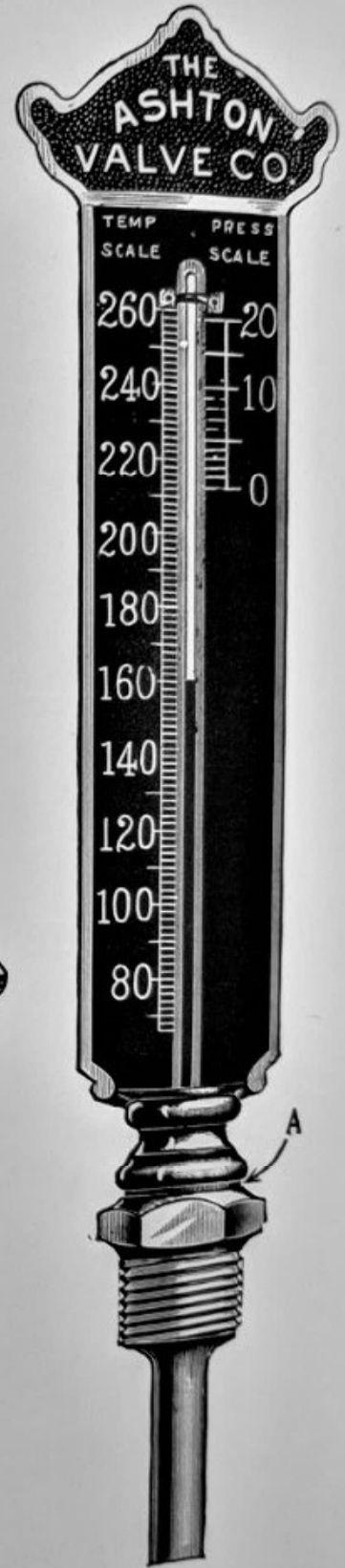

Fig. 2.

THESE thermometers made with either silvered or black metal dials handsomely finished. The Steam Thermometers have both Temperature and Pressure Scales.

PRICES.

Fig. 1. — Straight Stem Hot Water Thermometer	\$36.00 doz.
Fig. 2. — Straight Stem Steam Thermometer with Pressure Scale,	39.00 "
	42.00 "

Pyrometers.

500 to 3,000 Degrees.



Adapted for Annealing Ovens, Blast Furnaces, Bakers' Ovens, Glass Works, Boiler Flues, Chimneys, etc.

Applicable to any of the various operations where a certain fixed temperature is conducive to the best result.

THESE Pyrometers are manufactured under the Brown patents, and are now the most widely and favorably known. They are specially adapted for high temperatures, and are unequalled in durability and accuracy.

When ordering or inquiring about Pyrometers, give approximate temperature (if above red heat, give the color), and specify the dimensions of the oven, pipe, or flue, and thickness of the outside wall; also the depth and fluctuations of melted metals, that the stem may be made and adjusted to suit each particular operation. For temperatures above red heat the Pyrometer should be vertical. All Pyrometers should be cleaned and tested periodically.

PRICES.

Annealing Oven Pyrometer to 3,000 degrees	\$75.00
Hot Blast or Stationary Pyrometer to 1,200 or 1,800 degrees	40.00
Bakers' Oven Pyrometer to 800 or 1,200 degrees	25.00

Write for Discounts.

Telegraph Cipher. — Continued.

STYLE OF CASES FOR GAGES AND CLOCKS.

Improved Single Spring Bourdon Pressure or Vacuum Gages.

Arthur	Iron Case, Brass Ring.
Benny	Iron Case, Nickel Plate Ring.
Charlie	Brass Case.
David	Nickel Plate Case.
Edward	Brass Deep Case, O. G. or Octagon Ring.
Frank	Nickel Plate Deep Case, O. G. or Octagon Ring.

The Ashton Patent or Double Spring Bourdon Pressure Gages.

Gertrude	Iron Case, Japanned.
Hattie	Iron Case, Nickel Plate Ring.
Isabel	Brass Case.
Jennie	Nickel Plate Case.
Kate	Brass Deep Case, O. G. or Octagon Ring.
Louise	Nickel Plate Deep Case, O. G. or Octagon Ring.

NOTE. — When ordering Gages, be particular in stating diameter of Dial and style of Case.

Apple	No. 50.	Ashton Patent Steam Gage.
Apricot	No. 51.	Ashton Single Spring Bourdon Steam and Pressure Gage.
Banana	No. 52.	Ashton Improved Double Spring Gage (Lane Improvement).
Citron	No. 53.	Ashton Improved Vacuum Gage.
Dates	No. 54.	Ashton Compound Pressure and Vacuum Gage.
Grape	No. 55.	Ashton Hydraulic Gage.
Peach	No. 56.	Ashton Combination Water Pressure Gage.
Pear	No. 57.	Ashton Ammonia Gage.
Plum	No. 58.	Ashton Pyrometer Steam Gage.
Prune	No. 59.	Ashton Standard Test Gage.
Prunella	No. 60.	Ashton Altitude Gage.
Quince	No. 61.	Ashton Diaphragm Gage.
Raisin	No. 62.	Ashton Duplex Air Brake Gage.
Tomato		Edson Pressure Recording Gage.
Turnip		Peerless Pressure Recording Gage.
Agate	No. 63.	Locomotive and Marine Clock.
Whirl	No. 64.	Improved Engine Register.
Alloy		Gage Frame for Set four Dials, No. 1 Pattern.
Aluminum		Gage Frame for set five Dials, No. 2 Pattern.

NOTE. — Specify Ash, Oak, or Walnut, and SIZE Dial.

Aniline	No. 65.	Square counters (Large Size).
Antique	No. 66.	Square counters (Small Size).
Asphalt		Thompson Improved Indicator.
Auction		The Pantograph.
Arbor		Amsler's Polar Planimeter.
Baking		Compression Gage Cocks.
Basins		Bronzed Iron Water Columns.
Bedim		Common Water Gages.
Bicycle		Gage Hand Puller.
Bouncer		Common Steam Whistle.
Chime		Chime Steam Whistle.
Thermo		Steam and Hot Water Thermometers.

Where several Figures or Styles are mentioned in catalogue.

Uno	Figure one, or style one.
Duo	Figure two, or style two.
Trio	Figure three, or style three.
Quarto	Figure four, or style four.

Useful Information. — *Continued.*

THE area of the steam piston, multiplied by the steam pressure, gives the total amount of pressure exerted. The area of the water piston, multiplied by the pressure of water per square inch, gives the resistance. A margin must be made between the power and resistance, to move the pistons at the required speed; usually reckoned at about 50 per cent.

.

To find the area of a required pipe, the volume and velocity of water being given, multiply the number of cubic feet of water by 144, and divide the product by the velocity in feet per minute. The area being found, it is easy to get the diameter of pipe necessary.

.

To find the capacity of a cylinder in gallons: Multiplying the area in inches by the length of stroke in inches will give the total number of cubic inches; divide this amount by 231 (which is the cubical contents of a gallon in inches), and the product is the capacity in gallons.

.

To find the diameter of a pump cylinder to move a given quantity of water per minute (100 feet of piston being the speed), divide the number of gallons by 4, then extract the square root, and the result will be the diameter in inches.

.

To find the pressure in pounds per square inch of a column of water, multiply the height of the column in feet by .434. (Approximately, every foot elevation is called equal to one-half pound pressure per square inch.)

.

To find the velocity in feet per minute necessary to discharge a given volume of water in a given time, multiply the number of cubic feet of water by 144, and divide the product by the area of the pipe in inches.

.

To calculate the horse-power of a boiler. For horizontal, tubular and fire-boiler cylinders, multiply the number of feet of heating

Useful Information. — *Continued.*

BOILER CONSTRUCTION.

IRON rivets in single shear have a strength of 38,000 pounds per sectional inch, and 70,000 pounds in double shear.

.

The pitch of a rivet is the distance between the centre of one rivet hole to the centre of adjoining hole in the same row of rivets.

.

The best American practice provides, upon one-quarter inch plates, for a rivet five-eighths in diameter, and a pitch of 2 inches for single riveting, and a pitch of 3 inches for double riveting. For each increase of one-sixteenth inch in thickness of plate, add one-sixteenth to the diameter of the rivet and one-sixteenth to the pitch for single riveting, and for double riveting add one-sixteenth inch to the diameter of rivet and one-eighth to pitch.

.

To find strength of solid sheet: Multiply pitch of rivets by thickness of sheet and by tensile strength.

.

To find strength of sheet between rivet holes: Multiply the distance between edges of two holes by thickness of sheet and by its tensile strength.

.

To find resistance of rivets to shearing: Multiply area of rivet hole by number of rivets to be sheared, and this product by 38,000 for single shear or 70,000 for double shear.

.

Note whether strength of sheet between holes, or resistance to shearing, is the smaller, and divide this smaller result by the strength of solid sheet. Quotient obtained is the efficiency of joint in percentage.

.

To find bursting pressure of boilers: Multiply tensile strength by thickness of iron and divide product by radius.

.

To find safe working pressure: Divide the bursting pressure by 6.

.

To prevent bursting of boilers from



OFFICE AND WORKS, BOSTON, MASS.

Office and Works

BOSTON

MASS.

U.S.A.

THE

Ashton

Valve

Company

1896

Second Edition.

Branch Offices

NEW YORK

CHICAGO

LONDON

Established, 1871.

Capital, \$150,000.

Incorporated, 1877.

EDWARD P. MASON, President.

FRED A. CASEY, Vice-President.

ALBERT C. ASHTON, Secretary and Treasurer.

THE ASHTON VALVE COMPANY

MANUFACTURERS OF THE

ASHTON LOCK-UP POP SAFETY VALVES

FOR LOCOMOTIVE, STATIONARY, MARINE,
AND PORTABLE BOILERS

Ashton Water Relief Valves, Hydraulic Relief Valves,
Cylinder Relief and Snifting Valves

AND

ASHTON PRESSURE and VACUUM GAGES

OF EVERY DESCRIPTION, ALSO

REVOLUTION COUNTERS, ENGINE REGISTERS, LOCOMOTIVE AND
MARINE CLOCKS, PRESSURE RECORDING GAGES, WATER
GAGES, GAGE COCKS, WATER COLUMNS, TEST
PUMPS, THERMOMETERS, PYROMETERS,
AND ENGINE AND BOILER STEAM SPECIALTIES IN GENERAL



MAIN OFFICE AND WORKS:

BOSTON, MASS., U.S.A. . . 271 Franklin Street.

BRANCH OFFICES:

NEW YORK, N.Y.,
121 Liberty St.

CHICAGO, ILL.,
218 Lake St.

LONDON, ENGLAND,
1 & 2 Rangoon St.

SPECIAL AGENCIES:

PHILADELPHIA, PA.
PITTSBURGH, PA.

CLEVELAND, OHIO.
ST. LOUIS, MO.

ST. PAUL, MINN.